

Kentucky Logging BMP Field Guide

A field guide to the minimum requirements for logging
Best Management Practices in Kentucky



University of Kentucky
College of Agriculture,
Food and Environment
Cooperative Extension Service

Agriculture and Natural Resources
Family and Consumer Sciences
4-H Youth Development
Community and Economic Development



Kentucky Logging BMP Field Guide

*A field guide to the minimum requirements for logging
Best Management Practices in Kentucky*

Jeffrey W. Stringer
Department of Forestry and Natural Resources
College of Agriculture, Food and Environment
University of Kentucky

Contributors:
Larry Lowe and Tim Metzger
Kentucky Division of Forestry

Acknowledgments:

This publication was supported with funds from USDA-NIFA Renewable Resources Extension Act and the US Environmental Protection Agency, 319 Nonpoint Source Management Program through the Kentucky Division of Water.

The author thanks the Kentucky Division of Forestry, Kentucky Forest Industries Association, and the Kentucky Forestry Best Management Practices Board for assistance and collaboration in development of this publication.

Photographs and images provided by the author, with the exception of those listed below:

- 2a Larry Lowe, Kentucky Division of Forestry
- 6a Mike Floyd, US Fish and Wildlife Service, Kentucky Field Office
- 7.5 Byron Nelson, Kentucky Division of Forestry
- 7.6a Tim Queary, University of Kentucky, Department of Forestry and Natural Resources
- 7.6b Byron Nelson, Kentucky Division of Forestry
- 7.8 John Overstreet, University of Kentucky, Department of Forestry and Natural Resources
- 7.13a Daniel Bowker, University of Kentucky, Department of Forestry and Natural Resources
- 8.7b Indiana Department of Natural Resources
- 9.2 Larry Lowe, Kentucky Division of Forestry
- 9.3 John Auel, Mississippi State University
- 9.9b Charlie Blinn, University of Minnesota, Department of Forest Resources
- 9.12 Kentucky Division of Forestry
- 12.7a Larry Lowe, Kentucky Division of Forestry

Contents

1	What is in This Field Guide	5
2	Sources and Types of Water Pollution	7
3	Kentucky's Best Management Practices Minimum Requirements	11
4	BMP Measurements	17
5	Logging Inspections and Enforcement	19
6	Planning	25
7	Streams and Channels, Sinkholes, Wetlands	31
8	Crossings	55
9	Haul Roads, Trails, and Landings—Construction, Use and Maintenance	69
10	Other Disturbed Ground	83
11	Fluids and Trash	85
12	Roads, Trails, and Landings—Retirement	87
13	Closeout	103
14	Appendices	105

Chapter 1

What Is in This Field Guide

In Kentucky, the use of appropriate Best Management Practices (BMPs) for timber harvesting operations are required by the Kentucky Forest Conservation Act (KFCA - KRS 149.330 to 149.355). The BMPs found in this guide are practices designed specifically for logging operations to use before, during, and after timber harvesting. If implemented correctly they will reduce or eliminate water pollutants that have the potential to be generated from logging operations where drainage channels and water bodies are present.

This guide is designed as a field reference for loggers to help meet the mandatory BMP minimum requirements for water quality protection. The guide contains the minimum requirements for each BMP and recommendations that can be used to effectively and efficiently implement the minimum requirements. Additional references are also provided to help loggers with the BMP inspection process and other water quality regulations.

Chapter 2

Sources and Types of Water Pollution

Logging has the potential to pollute water by introducing substances or creating detrimental conditions in streams and other waters. Logging pollution is considered "non-point source pollution" and can negatively impact aquatic life. Common pollutants from logging operations are outlined below.

Sediment is the most common logging pollutant in Kentucky. Haul roads, skid trails, and landings (log decks) are areas of disturbed ground that can erode. The resulting muddy water runoff has the potential to reach streams and other water bodies, either directly or indirectly, through channels and ditches. Muddy water can also occur from soil being pushed into streams, channels or sinkholes. Excessive sediment can degrade water quality and create deposits on the bottom of streams that negatively affect aquatic life such as fish, mussels, crayfish and insects.



Sediment from skidding.

Logging debris including tops, limbs, cut offs, and other woody debris that are left in streams can pollute waters. This is because they can change how water flows leading to increased bank erosion that produces sediments. In some cases debris can also decompose resulting in lower oxygen levels, harming aquatic life.



Logging debris from felling and topping.

Water temperature increase caused by excess sunlight from the removal of too many trees adjacent to a stream can increase water temperature and lower oxygen. The increased sunlight can also cause detrimental algae in waters that are high in nutrients. All of these can result in harm to aquatic species.



Water temperature, increased due to harvesting of trees next to the stream.

Fluids like diesel fuel, gasoline, oil, hydraulic fluid and anti-freeze and others used in logging have the ability to harm aquatic life. These fluids come from equipment leaks, accidental hose and equipment breakage, improper care of fluids generated during equipment maintenance, and improper disposal of fluid containers and filters. Controlling fluids is important in preventing pollution.



Fluids improperly disposed of.

Trash including oil and fluid cans, filters, discarded parts, and left over meal and personal items can contribute to water pollution and should be properly disposed of.



Trash, personal items left after logging.

Chapter 3

Kentucky's Best Management Practices Minimum Requirements

BMP 1: Access Roads, Trails, and Landings

Location, Construction, Maintenance

- MR 1.1** ACCESS ROADS and TRAILS shall be constructed to minimize grade.
- MR 1.2** To avoid runoff from entering STREAMS or CHANNELS access roads and trails shall be located, constructed, maintained and WATER CONTROL STRUCTURES installed at appropriate intervals to drain surfaces, reduce erosion of road and trail surfaces and the undisturbed forest floor.
- MR 1.3** LANDINGS shall be constructed to drain and avoid runoff from entering streams or channels.
- MR 1.4** Skidders or other logging equipment shall not be operated under conditions that may cause the development of ruts that contribute to water quality degradation and cannot be resurfaced with AVAILABLE EQUIPMENT.
- MR 1.5** Practices shall be implemented to control erosion that can deliver sediment to streams or channels from disturbed ground other than roads, trails, and landings.

Stream Crossings

- MR 1.6** Where economically and/or topographically feasible, ELEVATED CROSSINGS (ex. bridges, culverts, pole crossings, etc.) shall be used when crossing streams (perennial and intermittent) and EPHEMERAL CHANNELS.
- MR 1.7** If it is not feasible to install an elevated crossing, FORDS with firm and/or protected stream or channel beds shall be used to cross streams and channels at right angles.
- MR 1.8** Avoid depositing soil into the stream or channel.
- MR 1.9** Immediately stabilize disturbed ground associated with crossings (excluding the active trail or road surface) to reduce runoff into streams.

Retirement and Inactive Jobs

- MR 1.10** On roads, trails, and landings that are TEMPORARILY INACTIVE practices shall be promptly implemented to minimize erosion and runoff entering streams or channels.
- MR 1.11** Upon completion of harvesting activities PERMANENT RETIREMENT PRACTICES shall be implemented on roads, trails, and landings and other areas of disturbed ground to minimize erosion and runoff from entering streams or channels. Permanent retirement practices include the use of appropriate practices including: resurfacing, removing BERMS and other impediments to allow drainage and correct installation of permanent water control structures to drain surfaces and minimize erosion; removal of temporary stream and channel crossings; correct installation of permanent water control structures to drain surfaces and minimize erosion; and seeding and measures to promote the development of vegetative cover that may include one or more of the following; loosening compacted soil, fertilization, mulching, or liming.
- MR 1.12** After silvicultural and harvest activities are completed landowners should restrict vehicle access on retired roads, trails and landings until the site is stabilized.

BMP 2: Revegetation of Silvicultural Disturbed Areas

For revegetation associated with logging operations see MR 1.11. This BMP is required for landowners that are engaged in silvicultural operations and required to generate an Agriculture Water Quality Plan.

BMP 3: Streamside Management Zones (SMZ)

In areas adjacent to PERENNIAL and INTERMITTENT STREAMS, lakes, or other WATER BODIES, the use of STREAMSIDE MANAGEMENT ZONES (SMZs) is required. Management activities are acceptable within SMZs however SMZ requirements for perennial, intermittent, and COLDWATER AQUATIC HABITATS must be followed. SMZ requirements include maintaining ORIGINAL OVERSTORY TREES and minimum surface distances from the bank, with the exception of designated crossings, where the construction and/or use of roads, trails, and landings is avoided where feasible.

SMZ Perennial Streams and Water Bodies

- MR 3.1** Adjacent to perennial streams and perennial water bodies SMZs require retention of 50 percent of the original overstory trees for minimum surface distances of 25 feet on ground with less than (or equal to) 15% slope and 50 feet for ground with more than 15% slope.
- MR 3.2** Adjacent to perennial streams and perennial water bodies SMZs require minimum surface distances for roads, trails, and landings of 50 feet on ground with less than (or equal to) 15 percent slope and 100 feet for ground with greater than 15 percent slope.
- MR 3.3** In areas adjacent to designated coldwater aquatic habitats, SMZs require the retention of 75 percent of the original overstory trees and a minimum surface distance for roads, trails, and landings of 100 feet regardless of slope. Disturbance of understory vegetation in coldwater aquatic habitat SMZs should be minimized.

SMZ Intermittent Streams

- MR 3.4** Adjacent to intermittent streams or other intermittent water bodies SMZs require minimum surface distances for roads, trails, and landings of 50 feet on ground with less than (or equal to) 15 percent slope and 100 feet for ground with greater than 15 percent slope.

Table 7.1. Streamside Management Zone Overstory Retention and Minimum Distances

Stream type	Over-story Width		Overstory Retained ¹	Minimum Distance to Roads, Trails, and Landings	
	Slope			Slope	
	<15% ²	>16% ³		<15% ²	>16% ³
Regular Perennial	25 ft	50 ft	50%	50 ft	100 ft
Intermittent	0 ft		0%	50 ft	100 ft
CWAH	100 ft		75%	100 ft	

¹ Values represent the minimum retention required. Retention above these levels is allowed.

² Less than or equal to a slope percent of 15.

³ For any slope greater than 15 percent.

MR 3.5 Except at designated crossings, roads, trails and landings shall be located, where feasible, outside SMZ MINIMUM SURFACE DISTANCES. Where it is not feasible to maintain minimum required distances, extra measures are required during and after use to reduce and restrict down slope runoff to streams. These include the appropriate use of the following practices: minimizing road and trail grade; preventing runoff from accumulating at low points along roads, trails and landings; increasing water control structure frequency; and adequate use of logging debris and or other natural or man-made sediment barriers to stop or reduce down slope movement of runoff to streams.

Debris and Soil in Streams and Channels

MR 3.6 DISTURBED SOIL or LOGGING SLASH including tops shall not be left in or have the potential to be washed into perennial or intermittent streams.

MR 3.7 Logging slash that blocks the flow of water shall not be left in EPHEMERAL CHANNELS.

Equipment in Streams

MR 3.8 Streams and ephemeral channels must not be used as roads, trails, or the loading of logs unless topography or other circumstance leaves no other alternative for access or when use of streams and channels would create less water quality degradation than constructing new or using existing roads and trails. In these circumstances the stream or channel bed should be used only for the minimum distance necessary.

BMP 4: Sinkholes, Sinking Streams and Caves

MR 4.1 Runoff from roads, trails and landings shall not drain into SINKHOLES, SINKING STREAMS, or CAVES. (Note that if runoff does enter a sinkhole, a UIC [UNDERGROUND INJECTION CONTROL] permit may be required.)

MR 4.2 Soil and logging debris shall not be concentrated or actively accumulated in a sinkhole.

BMP 5: Fluids and Trash

- MR 5.1** Equipment fluids shall not be drained onto the ground and should be collected, transported off site and disposed of properly.
- MR 5.2** Equipment shall not be left on or adjacent to stream banks.
- MR 5.3** All TRASH shall be properly disposed of off-site.

BMP 6: Proper Planting of Tree Seedlings by Machine

This BMP is required for landowners that are engaged in silvicultural operations and required to generate an Agriculture Water Quality Plan. If a logging operation is machine planting trees, for example to re-establish an SMZ, then adherence to this BMP would be required. Consult the most recent version of the Statewide Water Quality Plan.

BMP 7: Fertilization

- MR 7.1** In silvicultural operations fertilizer should be applied in compliance with label directions and avoid application within 30 feet from any sinkholes or noticeable openings.

BMP 8: Application of Pesticides

Most logging operations are not applying pesticides, including herbicides. If pesticides are being used adherence to the minimum requirements of this BMP is required. Landowners that are engaged in silvicultural operations and required to generate an Agriculture Water Quality Plan must follow the minimum requirements in this BMP.

BMP 9: Site Preparation for Reforestation

This BMP is required for landowners that are engaged in silvicultural operations and required to generate an Agriculture Water Quality Plan. If a logging operation is using intensive practices to prepare the site for planting trees and controlling competing vegetation then adherence to this BMP would be required. Consult the most recent version of the Statewide Water Quality Plan.

BMP 10: Silviculture in Wetland Areas

When logging is undertaken in wetland areas, all forestry BMPs should be used. In addition the following minimum requirements are to be used.

- MR 10.1** When silvicultural activities including harvesting are implemented in WETLANDS, additional BMPs shall be used including: minimizing construction of roads, locating landings on higher ground, and minimizing vehicle traffic.
- MR 10.2** Crossing of streams and sloughs should be avoided. If not possible follow appropriate stream crossing requirements of BMP 1.

Chapter 4

BMP Measurements

Effective and efficient use of BMPs requires two measurements;

1. steepness (or slope) of the ground, and
2. distance.

BMPs that require the use of these measures include:

- width of standing trees in streamside management zones
- distance of roads, trails, and landings from water bodies in streamside management zones
- spacing of water control structures on haul roads during use
- spacing of water bars or other water control structures on retired skid trails and roads.

Slope

Steepness is measured using SLOPE PERCENT. Slope percent is the rise or fall in feet over 100 feet of horizontal distance. Figure 4.1 is a diagram of a 20 percent slope.

Figure 4.1. Diagram of a 20 percent slope. In this example, 20 feet (rise or fall) ÷ 100 feet (horizontal) × 100 = 20 percent slope. Note that there is no positive or negative.

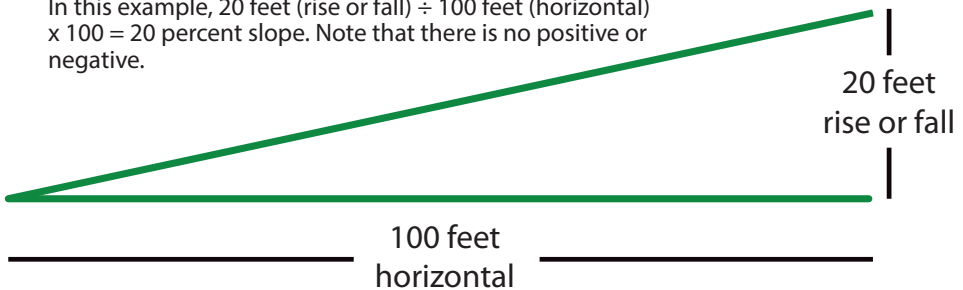

Distance

When distance is used in BMP minimum requirements or recommendations it refers to distance as measured across the ground (referred to as slope distance) and not horizontal distance.

Chapter 5

Logging Inspections and Enforcement

Under the Kentucky Forest Conservation Act (KFCA, statute KRS 149.330 - 149.355) the Kentucky Division of Forestry (KDF) has the authority to inspect commercial timber harvests for the use of appropriate BMPs and the presence of a Kentucky Master Logger (KML). By statutory definition, a commercial timber harvest does not include the following:

- cutting of firewood or Christmas trees
- clearing rights-of-way for highway or utilities unless the timber is sold
- cutting timber by an individual non-industrial landowner on his own land, if cut by the landowner himself
- clearing for farm purposes (farm is required to have an Agriculture Water Quality Plan)
- clearing incidental to coal mining (only applicable to permitted areas).

If a portion of the logging job fits one of these exemptions then only that portion of the job is exempt and the rest of the job is required to be in compliance with KFCA minimum requirements. Operations whose primary skidding is done with animals is exempted from having a KML on site and in charge. However, these operations must use the appropriate BMPs. See Appendix 4 for other laws and regulations potentially impacting logging operations.

Inspections

KDF county rangers have the authority to inspect commercial logging operations. While loggers are not required to notify the KDF of their operations, it is recommended they do so when starting an operation (see Appendix 1 for KDF contact information). Logging operations are required to use the appropriate BMP minimum requirements and maintain a Kentucky Master Logger on site and in charge of operations. While the logging firm is responsible for BMP use, anyone that is directly controlling the logging operation may also be held accountable including timber buyers, landowners, or consulting or industry foresters.

The following outlines the general procedures for inspections of active logging operations.

Step 1. Initial Inspection

During an initial inspection a KDF county ranger will identify the Kentucky Master Logger on site and in charge and discuss the job with them. The county ranger will map out established landings, roads, skid trails, as well as streams, ephemeral channels and other sensitive areas. They will inspect for the use of BMP minimum requirements.

An initial inspection form will be filled out and the logger will receive a copy. If appropriate minimum requirements are not in use a written warning will be issued. In the event that a Kentucky Master Logger is not present or the operation is creating, or there is a significant risk of, water pollution an emergency order can be issued to cease operations until the situation is corrected (see Violation section below). Also see Violation section for individuals or operations with two or more bad actor designations.

Step 2. Periodic and Compliance Inspections

After the initial inspection, periodic inspections are required until the job is completed. This involves mapping out and inspecting any new or existing roads, trails and landings. If any sections of roads, trails, and landings have been retired, and not re-entered a final inspection of these areas will be completed and those sections of the job will not be inspected further. Inspection will focus on ensuring compliance with all appropriate minimum requirements. As is the case with an initial inspection, if violations are found, a written warning is issued and the procedures found in the Violations section below will be followed.

If a problem was found a Compliance Inspection is conducted to see if the problem has been resolved. If it has been resolved the written warning is no longer in effect. If not other provisions outlined in the Violations section below will be triggered.

Step 3. Final Inspection

When the logging job is complete a final inspection will be conducted. It is helpful to contact the county ranger to make sure that they get to the site for the final inspection before leaving the job. If there are minor problems they can often be corrected immediately. Once the final inspection has been successfully completed the logger is no longer responsible for the site, unless undetected problems later arise.

Equipment Not On Site or Inactive Operations

Occasionally a logging site is found where it is evident that the harvest has been completed or the operation is inactive. If an inspection finds there are no BMP violations it is classified as an initial/final inspection and no further action is required. If violations are found then the appropriate action (example: issuing a written warning) will be taken. The county ranger is not required, but may attempt, to locate the logger responsible and if found the logger will be informed of the situation. The normal inspection process, appropriate for the violation, will be followed regardless of whether the logger was notified or not. If there is a significant environmental problem the appropriate government agency will be contacted such as the KY Department for Environmental Protection, U.S. Fish and Wildlife Service, or KY Division of Fish and Wildlife Resources.

Violations

Emergency Order

If a Kentucky Master Logger is not present (excluding a short necessary absence) or there is evidence of significant on-going or potential pollution, an emergency order will be issued and operations must cease. Plans will be made to bring the job into compliance. If not, further enforcement actions will be taken including the notification of other enforcement agencies.

BMP Violations

If inspections find that one or more of the appropriate BMP minimum requirements have not been implemented the following sequence of events will occur:

- **Written Warning**—A written warning will be issued to the owner/operator, in some cases this may not be the Kentucky Master Logger.
- **Compliance Inspection**—A re-inspection known as a compliance inspection will occur to ensure that the correct BMPs have been implemented in a timely manner.
- **Informal Conference**—An owner/operator can request an informal conference with the Kentucky Division of Forestry Regional Forester to discuss the situation. If it is decided that more BMP work is needed a plan and timeline will be developed to correct the issue.
- **Notice of Violation**—If the logging operation is still found to be out of

compliance with the BMP minimum requirements a notice of violation will be issued stating the corrective action required and the timeline for completion of that action.

- **Special Order**—If BMP minimum requirements are still not being addressed a special order is issued mandating the logger immediately cease all or a portion of the operation and implement appropriate BMPs or other corrective measures identified in the notice of violation. Operations can resume after an inspection determines the violation has been corrected.
- **Administrative Hearing, Bad Actor Designation and Fines**—If violations are not corrected the special order can include initiation of an administrative hearing that can result in a secretary’s order including a \$1,000 fine per violation and designation as a bad actor. The bad actor designation and fine will be issued to the owner/operator or those found to be in charge or directing the operation. Since bad actor designations are assigned for each violation a logger or operator can accrue multiple bad actor designations.

Bad Actors

Bad Actor designations are available to the public at www.masterlogger.org. There can be market repercussions associated with a Bad Actor designation such as mills not purchasing logs from bad actors. Operators with more than one bad actor designation are subject to special inspection protocols (see Multiple Bad Actor Designation below). Bad Actors can contact the KDF and after signing an agreement and successfully following a two year process involving KDF notification of all operations and compliance with the KFCFA minimum requirements the bad actor designation can be removed.

Multiple Bad Actor Designations—There are also inspection provisions specific for an operation where the Kentucky Master Logger or owner/operator has two or more bad actor designations as follows.

- **Two bad actor designations**—If a BMP problem is found a written warning will be issued and if not corrected in five working days the owner/operator will be notified to cease operations and correct the problem.
- **Three (or more) bad actor designations**—An emergency order will be

issued directing the logger or operator to immediately cease all timber harvesting operations in the Commonwealth. An administrative hearing will also be conducted. Operations can be initiated upon completion of site remediation work on jobs that were previously not in compliance with BMP use and fine payment or adherence to a fine payment plan.

Chapter 6

Planning

Planning a logging operation should start well before equipment is unloaded. Planning is important for saving money and avoiding water quality problems. Planning begins by determining where the water, drainage channels, sinkholes and other sensitive areas are located. The next step is to define the location of landings, haul roads, and primary skid trails. These are determined based on harvesting needs and minimizing the impact to water quality. The latter requires the use of BMPs. While helping to avoid water quality problems planning can also decrease skidding time and overall costs, ultimately increasing profits. Planning can best be accomplished by using a planning checklist and planning map.

Planning Checklist

The planning checklist is used to help determine information that should be considered when planning. The checklist helps to ensure that nothing has been missed. It also contains items that are control points that should be included on a harvest planning map. See Appendix 2 for a planning checklist.

Harvest Planning Map

A Harvest Planning Map is critical to developing an efficient and trouble free logging operation. Loggers can develop a map that includes information from the planning checklist. A map can be produced on a computer, using a topographic map or drawing a map by hand. Watermaps (see page 38) is a good source of topographic maps and aerial photographs that can be printed out or used to develop a planning map on the computer. Watermaps also shows special streams and other waters that are important in planning. A completed planning map shows the locations of the control points and other items from a planning checklist. Control points dictate where you can place roads, trails, and landings and where equipment can safely operate. Maps can also indicate areas of unmerchantable or inaccessible timber.

During a walkthrough additional control points and other information were added to the map (for the purposes of example these are in blue) including:

- location of old fescue field at the bottom of the hill
- wet area in field
- ephemeral channels in the hillside (dashed blue line)
- drainage ditches running through the field (dashed blue line)
- two areas containing good timber
- good crossing point along the ditch (C)
- good stream crossing point onto the island (C)
- potential locations for a landing (L)
- steep areas were verified as being too steep to skid or safely fell timber (blue hatch).

Planning the Location of the Roads, Trails and Landings

Once a walkthrough has been completed and the control points (including the SMZ locations) are on the planning map the location of the landings, haul roads, and the approximate location of primary skid trails can be drawn on the map (Figure 6.2). Use the control points and site features discussed above and guidelines in the BMP sections and the recommendations below to establish the location of landings, haul roads and primary skid trails.

- Locate landings away from streams and out of SMZs, where possible.
- Minimize the number of stream and channel crossings.
- Use appropriate type of crossing for the situation (see BMP 1).
- Try to locate haul roads on well-drained stable soils.
- Determine type or types of streams and maintain appropriate minimum streamside management zone (SMZ) distances (see BMP 3).
- Avoid sinkholes and other problem areas (see BMP 4).
- Avoid drainages such as ephemeral channels, where possible.
- Minimize grades on roads and trails (see BMP 1).
- Plan for drainage to go into areas that do not directly drain into streams and channels.

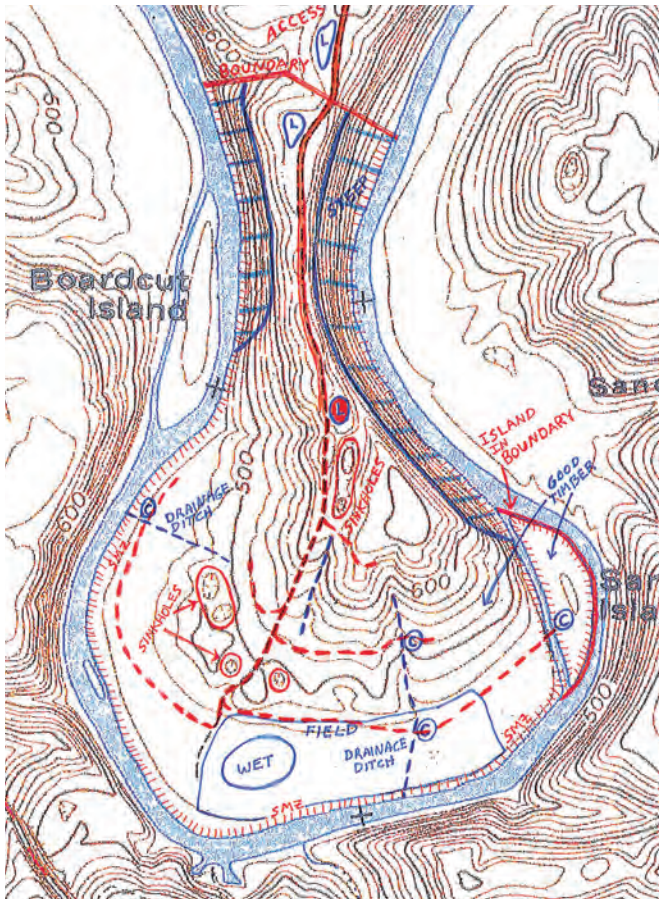

Figure 6.2. This is the final planning map containing the location of the haul road, landing, primary skid trail and stream, channel and ditch crossings.

In Figure 6.2 the haul road will use the old farm road (bold red line). The landing was located (filled red circle) to minimize skidding distance. Primary trails (dashed red line) were delineated and following old skid trails to the bottom. Three locations were marked where secondary skid trails would branch off to avoid the wet area and cross ephemeral channels, drainage ditches and access the island. Crossing locations were confirmed. A culvert will be used to cross the drainage ditch, steel pipes will be used for the two ephemeral channel crossings and a wooden skidder bridge will be used to access the island.

Hand Drawn Planning Map

A hand drawn planning map can often be as useful a topographic map (Figure 6.3). The basic shape of the boundary and stream (Green River) was taken from the topographic map as were the location of the sinkholes and the old farm road. The other items such as the wet bottom, drainage ditch, etc. were penciled in during the walkthrough. Also the proposed locations for a landing (x), haul road, primary skid trails, and crossing locations and types were also added to the hand drawn map.

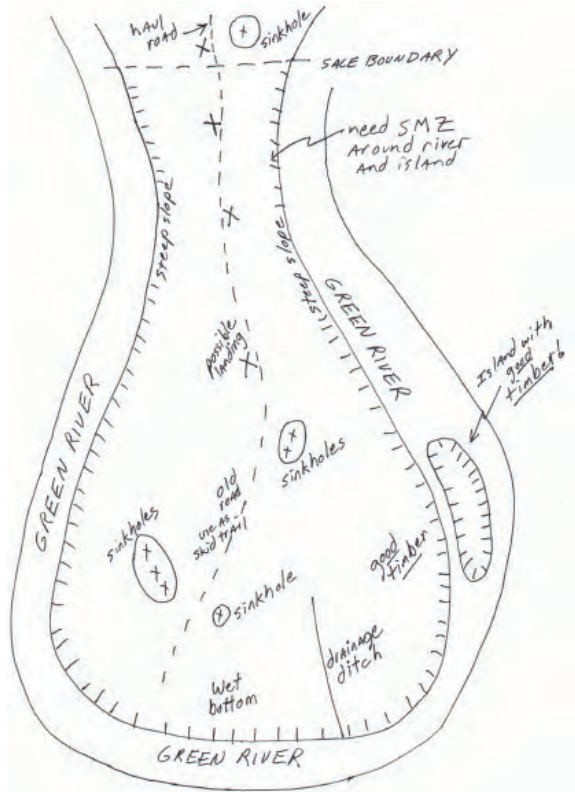

Figure 6.3. Hand drawn harvest planning map showing control points and other important information.

Planning Using Watermaps

Planning maps can be generated on the computer and there are a number of programs and online resources available that can be used. Watermaps (see page 38) is a planning tool designed for forestry operations in Kentucky. It provides topographic maps, aerial images, and information on stream locations and types including Exceptional Use Waters that need special protection. Watermaps allows users to draw on the maps, measure distances, and contains other useful tools that can be used to develop a harvest planning map. These maps can be printed or saved to the computer. See Appendix 3 for more information on Watermaps.

Chapter 7

Streams and Channels, Sinkholes, Wetlands

Identifying and Locating Water Bodies and Sensitive Areas

All water bodies must be protected from pollutants, directly and indirectly entering them, by implementing BMPs. This not only requires the use of BMPs directly adjacent to water bodies but also near ditches, ephemeral channels, and sinkholes that can carry pollutants. In some instances these ditches, channels and sinkholes may be several miles away from streams or other water bodies. Figure 7.0 is a diagram of a harvest site that is not directly adjacent to a stream. However, this harvest can easily result in stream pollution if muddy water from skid trails is not controlled. If no BMPs are used, significant amounts of sediment can run into channels located within the harvest and ultimately reach the stream.

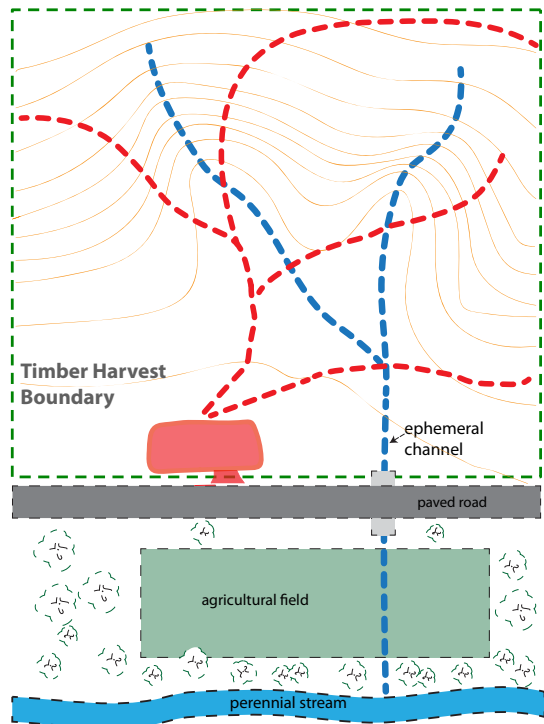

Figure 7.0. Ephemeral channel (dashed blue line) that starts on a hillside scheduled for harvest. The ephemeral channel runs under a public road and through a drainage ditch in an agricultural field before emptying into a perennial stream.

The first step in protecting water quality is locating streams and other water bodies. The type of stream or water body determines what BMPs must be used. The different types include:

- perennial streams and water bodies (lakes, ponds, sloughs)
 - regular streams and water bodies
 - Exceptional Use Waters
- intermittent streams
- sinkholes
- wetlands

Perennial Streams and Water Bodies

Perennial means containing water throughout the year. Examples are lakes, ponds, streams, and sloughs that contain water year round. Streams are the most common and include large rivers down to small creeks. Some small perennial streams may only contain standing pools during dry months and under extreme drought conditions may dry up. The majority of perennial streams in Kentucky have no special designation. However, there are a small percentage that are designated as Exceptional Use Waters. The following outlines the differences between regular streams and Exceptional Use Waters.

Regular Perennial Streams

Regular perennial streams comprise over 95 percent of the stream miles in Kentucky. They are technically considered warm water aquatic habitats. Larger perennial streams are blue lines on topographic maps. Some perennial streams are small enough that they may not show up on topographic maps, but all require Streamside Management Zones.

Exceptional Use Waters

Exceptional Use Waters are perennial streams that are high quality and require special attention and care when operating around them, or when operations contain ditches, channels, or sinkholes that ultimately drain into them. There are several types of Exceptional Use Waters including:

- **Trout streams (Cold Water Aquatic Habitats (CWAH))** designated by the Kentucky Department of Fish and Wildlife Resources that can hold native or stocked trout. There are special Streamside Management Zones designed to protect these streams.
- **Outstanding State Resource Waters** that are designated are the best quality streams found in a particular region of the state. These waters are monitored and careful adherence to BMP minimum requirements is recommended.
- **Outstanding State Resource Waters—Threatened and Endangered Species.** These streams contain one or more federally listed threatened or endangered aquatic species (ex. fish, mussels, crayfish, and shrimp). Strict adherence to BMP minimum requirements are a must and in some instances special provisions must be taken to protect these listed species.
- **Kentucky Wild Rivers** are sections of rivers where a corridor is protected to improve the view for those using it for recreational purposes. The protected corridor can be up to 2000 feet from the center of the river. Timber harvesting within the Wild River Corridor requires that a Change of Use permit be issued by the Office of Kentucky Nature Preserves prior to any logging activity. Contact the Office of Kentucky Nature Preserve's Wild River Program at 502-573-2886 or <http://naturepreserves.ky.gov>. Kentucky's Wild Rivers can be located using Watermaps (see page 38).

Intermittent Streams and Water Bodies

Intermittent streams, and other intermittent water bodies, look like perennial streams during winter and spring, but are dry during the summer and fall (Figure 7.1). When designated on topographic maps they may appear as dot and dashed blue lines, but may not always be shown on topographic maps. There are specific Stream-side Management Zone requirements for intermittent water bodies.



Figure 7.1. Intermittent stream (dry branch) in summer with no water present. The bed is gravel and banks are well defined. Logger has crossed this intermittent stream using a pole crossing.

Ephemeral Channels and Ditches

Most perennial and intermittent water bodies are fed by numerous naturally occurring channels. **Ephemeral channels** are naturally occurring drainages that carry rain water during storms or after snow melt. Typically they are dry between storms. Ephemeral channels by definition carry water directly to a stream or other water body. There are some instances where natural drainage ditches carry water down a hill but the water never reaches a stream, these are not considered ephemeral channels and generally are not a concern for water quality.

Ephemeral channels often resemble a very small stream having banks and beds with exposed rock, gravel, or mud (Figure 7.2). Because they carry water only after a storm, they are not considered streams and Streamside Management Zones are not required around them. However, because they are connected to perennial or intermittent streams (or to other bodies of water), they are subject to BMP requirements to keep logging debris from blocking them and to reduce, or eliminate, the amount of equipment fluids and muddy water runoff that enters them.

Drainage ditches are man-made, often found along roads, in agricultural fields, and in industrial and urban areas. Since most are connected in some manner to streams, they require the same BMP use as ephemeral channels.

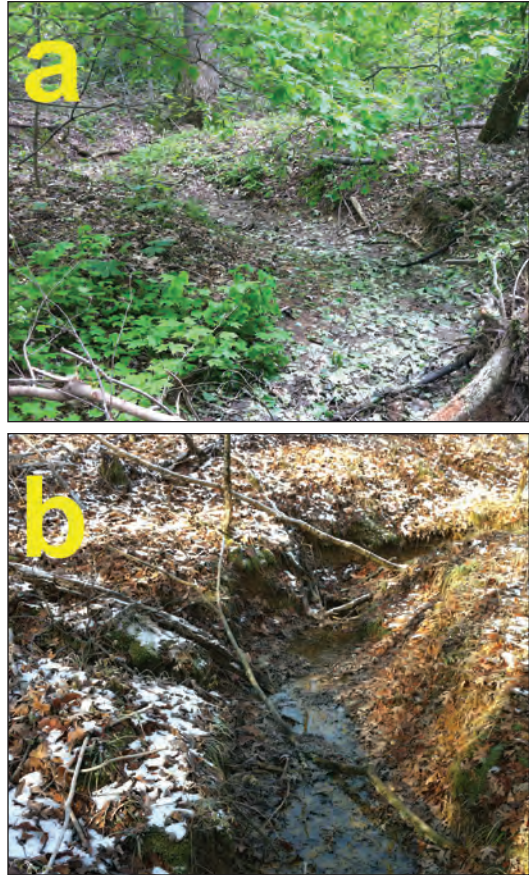

Figure 7.2. Ephemeral channel in summer with no water present (a) and the same channel with water flowing after a rain in the winter (b).

Sinkholes

Sinkholes include any natural opening where surface water can run into the ground. In Kentucky, sinkholes are normally found in karst topography (areas with limestone bedrock). If they have an opening in their bottom (swallet) it allows surface water to drain unfiltered into underground streams that ultimately empty into streams or lakes. BMPs are required to be used in and around sinkholes to keep muddy water runoff, concentrated logging debris, trash, and equipment fluids, out of sinkholes.

Wetlands

Wetlands are areas where the soil is wet most of the year having trees, shrubs, and groundcover that typically grows in wet soils. Currently, state law does not prohibit harvesting in wetlands. However, care must be taken to protect the significant amount of surface waters and channels that are present in wetlands. Wetlands require special care and minimum requirements are designed to reduce logging impact to these areas. It is important to note that some wetlands can be under federal jurisdiction and wetland designations and rules are subject to change.

Locating Streams, Channels, and Sinkholes

Topographic maps can help in determining the location of many streams, sinkholes, wetlands, and ephemeral channels. However, in some cases smaller ones may not be found on maps and a field check is the only way to verify their presence. A field check may also be needed to determine if a stream has been properly designated as a perennial or intermittent. Watermaps, an online resource for assisting in determining stream location and special designation, can also be used (see page 38). Figure 7.3 is a topographic map with both perennial and intermittent streams identified as well as ponds, sinkholes, and the potential locations of ephemeral channels.

- **Perennial Streams** are typically identified with solid blue lines, (blue line streams). However, the maps will not indicate if the stream is an Exceptional Use Water or a Wild River (see Watermaps, page 38). While topographic maps will show the larger streams and rivers as solid blue lines, small perennial streams may not be shown.

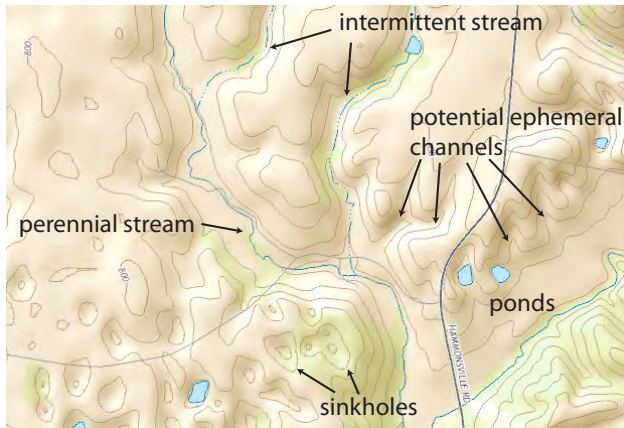

Figure 7.3. Examples of perennial (blue line) and intermittent (dot-dash blue line) streams, ponds, sinkholes, and potential locations of ephemeral channels.

- **Intermittent Streams** are typically dotted and dashed lines on topographic maps. There are a few locations in Kentucky where the intermittent streams on topographic maps are denoted with solid lines.
- **Ephemeral channels** are not specifically shown on topographic maps, but the maps can indicate their presence.
- **Sinkholes** can be located on topographic maps by looking for hatched concentric circles.
- **Wetlands**—especially prominent ones—are designated on topographic maps (Figure 7.4).

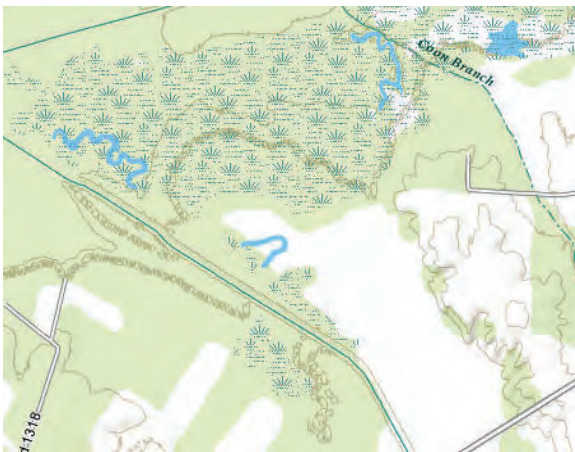

Figure 7.4. Example of wetlands delineated on a topographic map.

Watermaps

One of the easiest ways to access topographic maps and find out if a stream has a special designation is to use a free internet website called **Watermaps**. This website has been designed specifically for forestry applications by the Kentucky Division of Water to provide a means of generating topographic maps, locating Exceptional Use Waters, and perennial and intermittent streams for logging operations. Watermaps is the only resource that provides information on which streams are Exceptional Use Waters including trout streams (cold water aquatic habitats) and Outstanding State Resource Waters including those that have federally protected species in them. As new streams are listed as Exceptional Use Waters they will appear in Watermaps. A link to the Watermaps website, and instructions on how to use it, can be found at the Kentucky Master Logger website www.masterlogger.org. See Appendix 3 for more information on Watermaps.

BMPs for Streams and Other Water Bodies

This section contains BMPs specifically for use directly around streams and other water bodies and the channels and ditches that drain into them including:

- equipment in streams and channels
- logging debris and disturbed soil
- Streamside Management Zones (SMZs)
- sinkholes
- wetlands.

BMPs specific to construction, use, and retirement of roads, trails, and landings are contained in Roads, Trails, and Landings and Retirement sections.

Equipment in Streams and Channels

MR 3.8 Streams and ephemeral channels must not be used as roads, trails, or the loading of logs unless topography or other circumstance leaves no other alternative for access or when use of streams and channels would create less water quality degradation than constructing new or using existing roads and trails. In these circumstances the stream or channel bed should be used only for the minimum distance necessary.



Figure 7.5. Equipment operations in streams can cause pollution and directly impact aquatic species.

The minimum requirement is specific to using streams and ephemeral channels for haul roads, or for skid or forwarding trails, above what is needed for a crossing. It also addresses using stream or channel beds for loading. However, the requirement does allow for these operations in a stream or channel when it is the only way to access the tract, or a portion of it, or it can be shown that doing so will create less pollution than constructing roads or trails adjacent to the stream or channel. However, these circumstances are rare and require that the logger provide evidence that the provisions in the minimum requirement are being met. Stream sections that contain federally listed threatened and endangered species may exclude equipment operations in them, regardless of this minimum requirement. Also re-aligning streams, damaging banks, or altering flow is not permitted and loggers are at risk of violating state and/or federal law if doing so.

Logging Debris and Disturbed Soil

Streams (and other perennial or intermittent water bodies)

MR 3.6 Disturbed soil or logging slash (ex. tops and cutoffs) shall not be left in or have the potential to be washed into perennial or intermittent streams.

Logging debris includes disturbed soil, slash from felling, topping and delimiting operations, as well as cut-offs from bucking operations (Figure 7.6). Felling may result in tops in streams, or on banks, and they are required to be removed as soon as possible.



Figure 7.6. Logging operations have pushed soil into the stream channel and logging debris has accumulated to block stream channel (a). Topping has resulted in debris left in a small perennial stream (b).

Debris should be placed either out-of-reach of flood waters or lodged within, or placed behind, standing trees. Other woody debris, example cutoffs, and soil are not to be pushed into streams. Debris and soil can be used for crossings in accordance with the minimum requirement for stream and ephemeral channel crossings and removed directly after use.

Ephemeral Channels

MR 3.7 Logging slash that blocks the flow of water shall not be left in ephemeral channels.

This requirement is similar to that required for streams. However, some debris is allowed in a channel as long as it is not causing a blockage (Figure 7.7). Debris, particularly tops and limbs, can span an ephemeral channel or be left in the channel itself as long they do not block the flow or potentially block the flow of water. As is the case for streams, it is recommended that debris that blocks a channel is removed during felling and skidding operations. This is often cheaper than having to return to deal with debris once equipment has left the site.

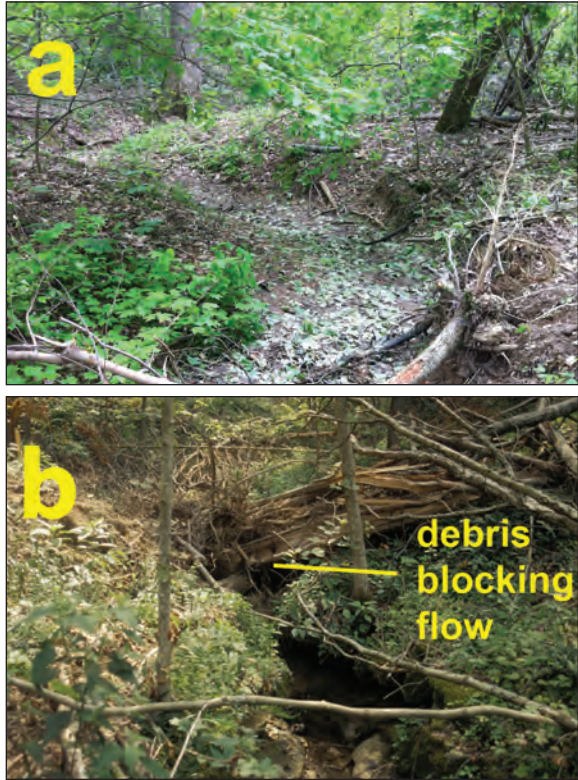

Figure 7.7. Unobstructed ephemeral channel (a). Debris from felling left in ephemeral channel that is blocking the flow of water (b).

Streamside Management Zones

Streamside Management Zones (SMZs) must be used directly adjacent to streams or water bodies (Figure 7.8).

SMZs should be marked prior to the start of logging. If SMZs are incorrectly implemented, or ignored, it is often extremely difficult or impossible to correct. SMZs are not required around ephemeral channels (Figure 7.9).



Figure 7.8. SMZ around the start of a small headwater stream in eastern Kentucky.

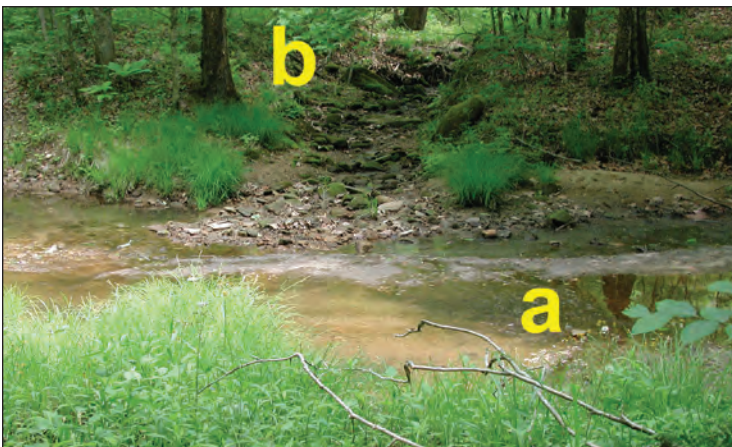

Figure 7.9. A regular perennial stream with flowing water in June (a). Perennial streams require SMZs. Contrast this to ephemeral channel (b) that only carries water into the perennial stream after a rain or snow melt.

SMZs are strips of land along streams or around lakes, ponds, and sloughs where two requirements must be met:

- for perennial water bodies a specific width and percentage of original overstory trees is required to be retained, and
- for both perennial and intermittent water bodies there are minimum distances to keep roads, trails, and landings from banks where feasible.

The specific requirements for SMZs are based on the type of water body and slope of the ground adjacent to the bank.

Table 7.1 provides information on overstory tree retention and minimum distances for roads, trails, and landings for regular perennial water bodies, cold water aquatic habitats (CWAH) that can hold trout, and intermittent streams. The specific minimum requirements for each are provided below.

Table 7.1. Streamside Management Zone Overstory Retention and Minimum Distances

Stream type	Over-story Width		Overstory Retained ¹	Minimum Distance to Roads, Trails, and Landings	
	Slope			Slope	
	<15% ²	>16% ³		<15% ²	>16% ³
Regular Perennial	25 ft	50 ft	50%	50 ft	100 ft
Intermittent	0 ft		0%	50 ft	100 ft
CWAH	100 ft		75%	100 ft	

¹ Values represent the minimum retention required. Retention above these levels is allowed.

² Less than or equal to a slope percent of 15.

³ For any slope greater than 15 percent.

SMZs for Regular Perennial Streams and Waters

The following minimum requirements are for regular streams (warm water aquatic habitats).

MR 3.1 Adjacent to perennial streams and perennial water bodies SMZs require retention of 50 percent of the original overstory trees for minimum surface distances of 25 feet on ground with less than 15% slope and 50 feet for ground with more than 15% slope.

MR 3.2 Adjacent to perennial streams and perennial water bodies SMZs minimum surface distances for roads, trails, and landings are 50 feet on ground with less than 15 percent slope and 100 feet for ground with greater than 15 percent slope.

Overstory Retention

Perennial streams and lakes, ponds, and sloughs must retain some of the original overstory trees around them to prevent exposure to excessive sunlight (Figure 7.10). Overstory trees are the taller trees forming the main canopy. They have crowns that have expanded and are exposed to full sunlight. Trees that are shorter than the main canopy are not overstory trees, nor are spindly trees that may be as tall as the main canopy trees but whose crown has not expanded. Original refers to the overstory trees that naturally would occur in the SMZ. Overstory trees can be a variety of sizes based on the size of the trees in the stand. Minimum requirement 3.1 for regular streams or water bodies calls for leaving 50 percent of the original overstory trees to limit a dramatic increase in sunlight and temperature to the stream. The overstory requirement starts at the bank and extends 25 feet away from the bank on relatively flat ground, less than or equal to 15 percent slope, and extends 50 feet for ground that is greater than 15 percent slope (Figure 7.11a).



Figure 7.10. Trees in green represent overstory trees. Trees in gray indicate trees that are not overstory trees and are classified as understorey or mid-story trees.

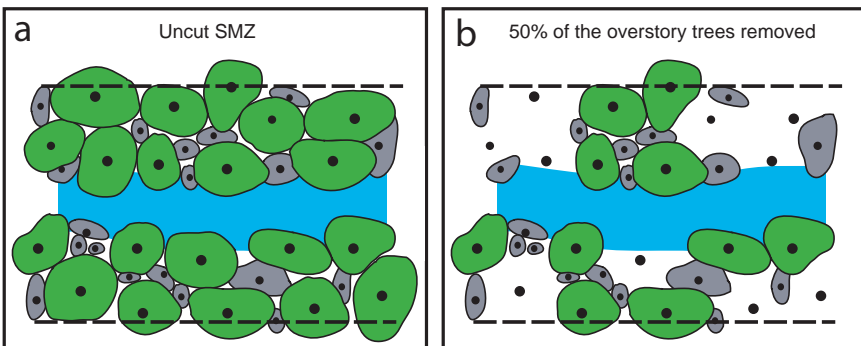

Figure 7.11. Uncut SMZ with overstory trees in green (a). 50 percent removal can be done in small groups (b - upper side) or as scattered individuals (b - lower side).

Fifty percent of the original overstory trees can be removed. Evenly scattered trees, i.e. every other one, can be removed or they can be taken in small groups (2 to 5 trees) (Figure 7.11b). If removing small groups of trees, for example 4 trees, the next 4 trees must be left regardless of their merchantability.

Minimum Distances for Roads, Trails, and Landings

Along with retaining overstory trees the SMZ for perennial water bodies also has minimum distances that roads, trails, and landings should be constructed from the stream or water body. Minimum requirement 3.2 requires that roads, trails and landings, where feasible, are kept 50 feet away from the bank on ground less than or equal to 15 percent slope and 100 feet from the bank where the ground is greater than 15 percent slope (Figure 7.12).

Figure 7.12. Diagram of SMZ requirements for a regular perennial stream.

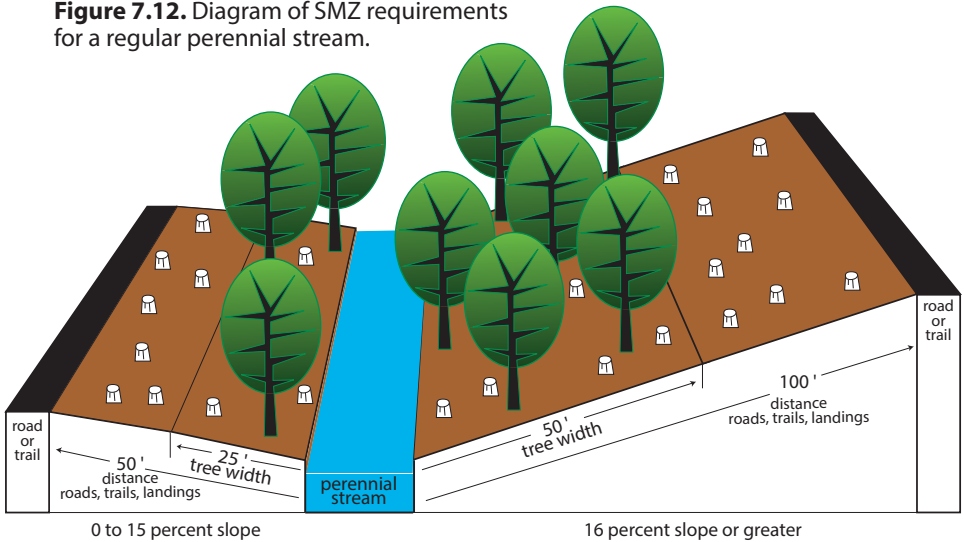

Extra Measures for Roads, Trails, and Landings Closer than Minimum Distances

MR 3.5 Except at designated crossings, roads, trails and landings shall be located, where feasible, outside SMZ minimum surface distances. Where it is not feasible to maintain minimum required distances, extra measures are required during and after use to reduce and restrict down slope runoff to streams. These include the appropriate use of the following practices:

- minimizing road and trail grade
- preventing runoff from accumulating at low points along roads, trails and landings
- increasing water control structure frequency; and
- adequate use of logging debris and or other natural or manmade sediment barriers to stop or reduce down slope movement of runoff to streams.

There are times when it is not feasible to locate roads, trails, and landings at the minimum distances. When they are closer extra measures must be implemented to reduce the amount of muddy water runoff. Techniques include increasing the number of water control structures or strategically placing logging slash to stop the downslope movement of water coming from water control structures (Figure 7.13).



Figure 7.13. Practices to implement inside of minimum SMZ distances include increased frequency of water control structures (a), or properly placed debris directly below water control structures to reduce runoff reaching streams (b).



Figure 7.14 shows an SMZ on a small perennial (solid blue line) and an intermittent stream (dashed blue line) in steeply sloping terrain in eastern Kentucky. The dashed yellow line indicates the 50 feet wide strip were 50 percent of the overstory was removed (a). The solid yellow line indicates the minimum distance of 100 feet for skid trails (b). C is the 100 feet minimum distance to skid trails in the intermittent stream SMZ. Overstory trees were winched from the SMZ to the adjacent skid trail. Area d is outside the SMZ where over 70 percent of the timber was removed and skid trails were constructed on the contour.

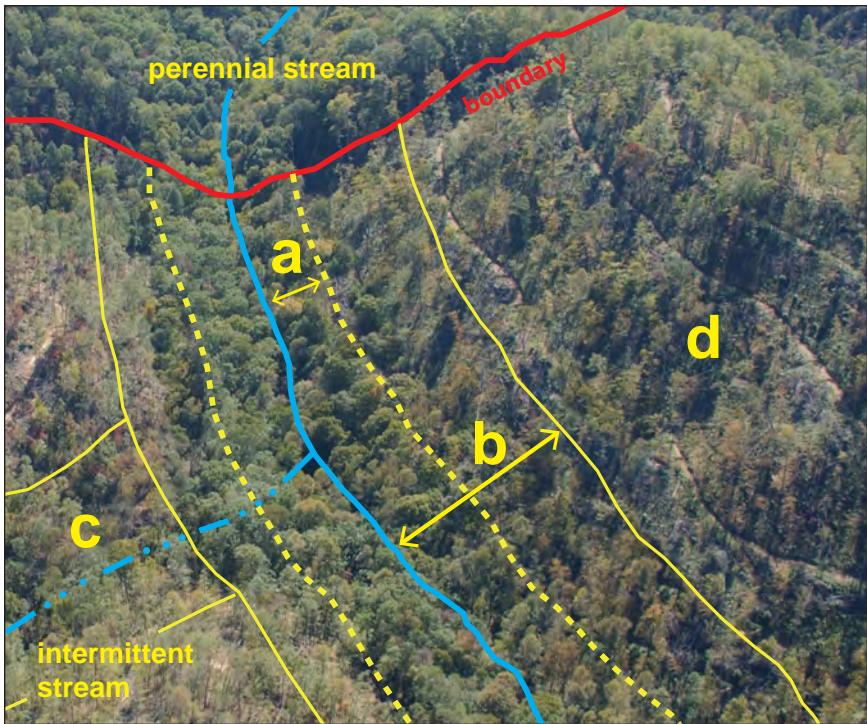

Figure 7.14. Diagram showing 50-foot SMZ leave tree distance (a), 100 feet minimum distance to a skid trail around both a perennial stream (b) and an intermittent stream (c), and the area beyond the SMZ (d) in steeply sloping terrain.

Exceptional Use Waters

Exceptional Use Waters include cold water aquatic habitats (trout streams) and other streams that have a special designated. Attention must be paid when operating next, or in proximity, to them. Below are the minimum requirements for operations next to Exceptional Use Waters.

Cold Water Aquatic Habitats—Trout Streams

MR 3.3 In areas adjacent to designated Cold Water Aquatic Habitats, SMZs require the retention of 75 percent of the original overstory trees and a minimum surface distance for roads, trails, and landings of 100 feet regardless of slope. Disturbance of understory vegetation in coldwater aquatic habitat SMZs should be minimized.

Cold Water Aquatic Habitats (CWAHs), known as trout streams that can, or do, hold native and stocked trout. Keeping the water cool means retaining more overstory trees for shade (75 percent) and maintaining a minimum distance to roads, trails, and landings of 100 feet regardless of slope (Figure 7.15). The requirement also requires, as practical, minimizing the disturbance to understory trees and shrubs.

When roads, trails, and landings are required to be constructed closer

Figure 7.15. Coldwater Aquatic Habitat (trout stream) overstory and road, trail and landing minimum distances.

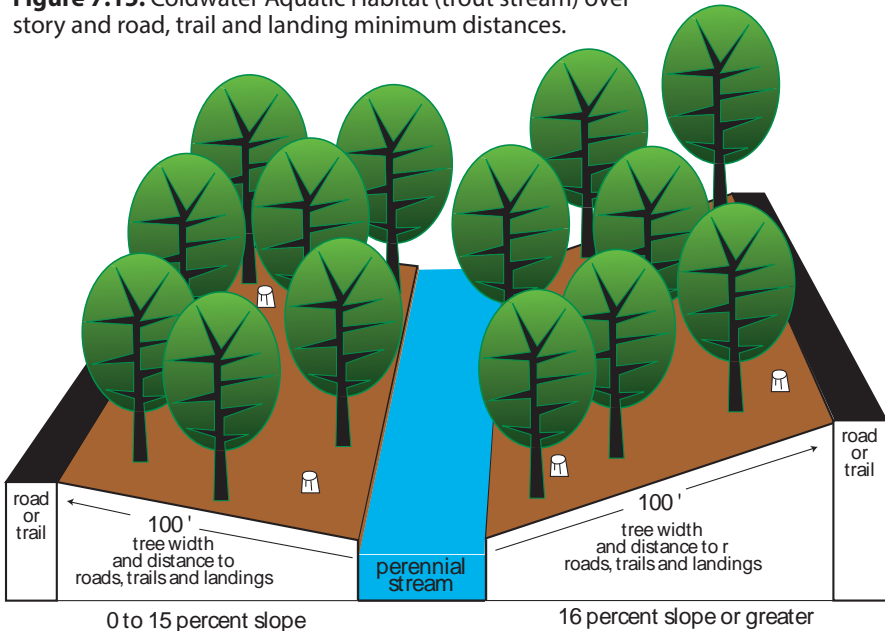

to the bank than the minimum distances allow, the special provisions outlined for regular streams (minimum requirement 3.5) must be implemented. Locations of trout streams can be found using Watermaps (see page 38).

Kentucky Wild Rivers

Kentucky Wild Rivers are sections of some of Kentucky's larger rivers that are protected for recreational use. Their protection extends from the center of the river up to 2000 feet. Timber harvesting within the Wild River Corridor requires that a Change of Use permit be issued by the Office of Kentucky Nature Preserves prior to any logging activity. For more information, contact Wild River Program at 502-573-2886 or <http://naturepreserves.ky.gov>

Outstanding State Resource Waters

These streams are recognized as being some of the highest quality streams for their region of the state. They are monitored regularly and special attention to BMP implementation is highly recommended when operating on or near these streams.

Outstanding State Resource Waters— Threatened and Endangered Species

These streams contain federally listed threatened and endangered species typically mollusks, fish, and crayfish. Under the federal Endangered Species Act is unlawful to kill or harm them, or to degrade their habitat. The Endangered Species Act may require that certain precautions above and beyond the state BMPs must be used along these streams or in areas that drain into them. These other precautions depend upon the species needing protection. Contact your local forester, county ranger, or natural resource professional for assistance.

Locating Special Designated Waters

All of Kentucky's Exceptional Use Waters, that include Cold Water Aquatic Habitats and Outstanding State Resource Waters, can be found using Watermaps an online mapping program developed by the Kentucky Division of Water specifically to aid forestry and logging operations (see page 38). Watermaps is updated as new Exceptional Use Waters are designated and new threatened and endangered species are found. Go to www.masterlogger.org for a link to Watermaps and instructions on how to use Watermaps to find streams and make planning maps for logging operations.

BMPs for Intermittent Streams

MR 3.4 Adjacent to intermittent streams or other intermittent water bodies SMZs require minimum surface distances for roads, trails, and landings of 50 feet on ground with less than 15 percent slope and 100 feet for ground with greater than 15 percent slope.

Overstory trees are not required to be left in SMZs along intermittent streams (Table 7.1). However, the intermittent SMZ does require the same minimum distances for roads, trails, and landings as regular perennial streams, where feasible (Figure 7.16a). When roads, trails, and landings are required to be constructed closer than the minimum distances allow, special provisions outlined for perennial streams must be implemented (see minimum requirement 3.5).

When significant cutting of trees occurs next to intermittent streams the potential for debris in the stream is increased as well as bank disturbance. Debris must be removed to comply with minimum requirement 3.6. While not a minimum requirement, leaving stream bank trees, where feasible, is recommended (Figure 7.16b).

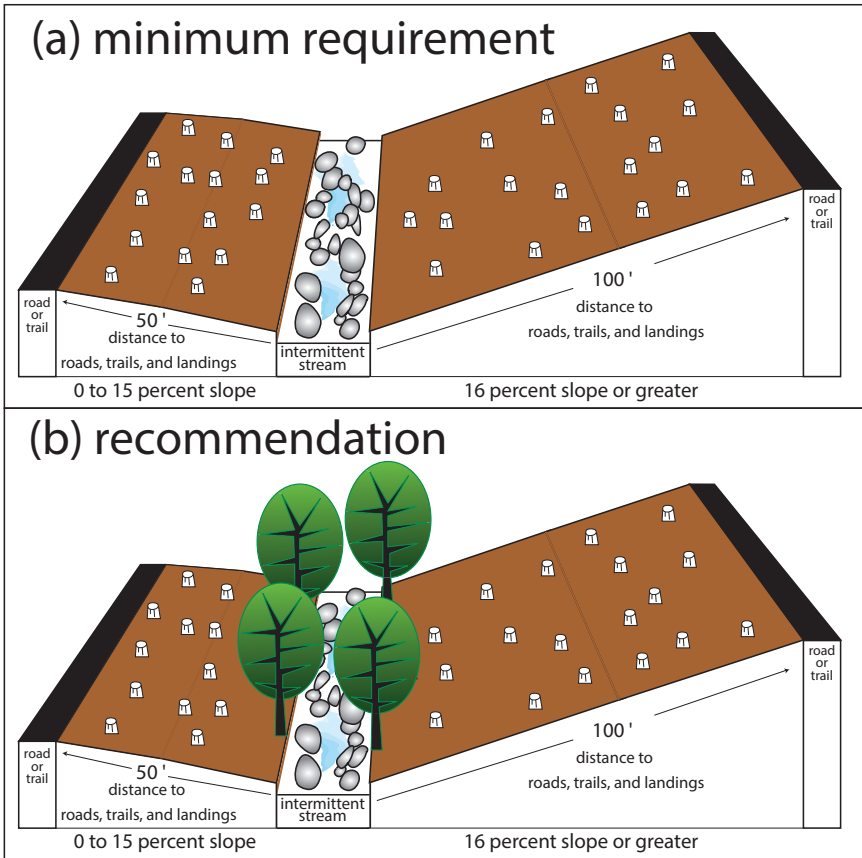

Figure 7.16. SMZ requirements for intermittent waterbodies with no overstory retention required and minimum distances for road, trail and landing (a). Leaving stream bank trees while not required is recommended (b).

BMPs for Sinkholes

BMP minimum requirements are to be used around sinkholes with openings and other naturally occurring openings in the ground. This is because soil, logging debris, and muddy water can continue unfiltered to underground streams that ultimately enter into streams or lakes.

- MR 4.1** Runoff from roads, trails and landings shall not drain into sinkholes, sinking streams, or caves.
- MR 4.2** Soil and logging debris shall not be concentrated or actively accumulated in a sinkhole.

Keep roads and trails out of sinkholes and away from the edge and keep water control structures from emptying into sinkholes, caves, or sinking streams (Figure 7.17). Likewise landings should be kept at a distance so that runoff will not drain into a sinkhole. Logging debris and other materials can be used if necessary to block runoff from entering sinkholes. However debris and soil cannot be pushed into a sinkhole. Debris generated from topping and delimiting may be left in sinkholes from felling operations where tops naturally fall into sinkholes. Accumulating tops in sinkholes is not permitted.

Figure 7.17. Diagram of sinkhole with road and trail away from the edge and only tree tops from the normal felling pattern are left in the sinkhole.

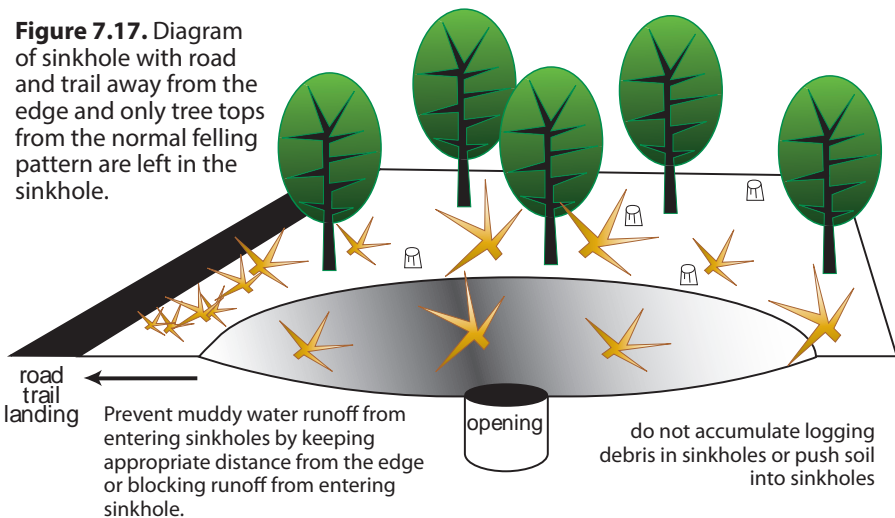

BMPs for Wetlands

MR 10.1 When silvicultural activities including harvesting are implemented in wetlands, additional BMPs shall be used including: minimizing construction of roads, locating landings on higher ground, and minimizing vehicle traffic.

MR 10.2 Crossing of streams and sloughs should be avoided. If not possible follow appropriate stream crossing requirements of BMP 1.

Wetlands occur throughout Kentucky, however they are more common in the western counties. All are close to, or contain, water throughout the majority of the year and water quality protection is an important issue in any wetland (Figure 7.18). Special attention to all BMP minimum requirements and the wetland minimum requirements (10.1 and 10.2) must be adhered to. Wetlands also have regulations that are specific to them and logging operations that drain, or contribute to draining, wetlands are not permitted.



Figure 7.18. Wetlands can include areas holding water throughout the year like this cypress swamp (a) or those that dry completely during summer months (b).

Chapter 8

Crossings

- MR 1.6** Where economically and/or topographically feasible, ELEVATED CROSSINGS (ex. bridges, culverts, pole crossings, etc.) shall be used when crossing streams (perennial and intermittent) and ephemeral channels.
- MR 1.7** If it is not feasible to install an elevated crossing, FORDS with firm and/or protected stream or channel beds shall be used to cross streams and channels at right angles.
- MR 1.8** Avoid depositing soil into the stream or channel.
- MR 1.9** Immediately stabilize disturbed ground associated with crossings (excluding the active trail or road surface) to reduce runoff into streams.

Crossings can be significant sources of sediment if attention is not paid to proper:

- location
- selection of crossing type
- installation and removal.

The four minimum requirements are designed to reduce muddy water runoff and soil deposited in the channel and to minimize disturbance of streams and ephemeral channels while providing operational flexibility. It is important to note that permitting through the Kentucky Division of Water may be required for some crossings, especially those where significant in-channel work is required in perennial streams. Consult Appendix 5 for guidelines that should be used when conducting in-channel work including using fords and other temporary crossings.

Elevating Crossings and Fords

- MR 1.6** Where economically and/or topographically feasible, ELEVATED CROSSINGS (ex. bridges, culverts, pole crossings, etc.) shall be used when crossing streams (perennial and intermittent) and ephemeral channels.

Elevated crossings support equipment above the stream or channel bed. They are to be used where economically and/or topographically

feasible. Economic feasibility requires that the value of what is skidded or hauled over a crossing can support installation, use, and removal of an elevated crossing. There are a wide range of elevated crossing options which will meet the minimum requirements and temporary skidder or forwarder crossings can often be constructed quickly and cheaply. However, topographic difficulties such as significant bank heights and stream or channel widths can make the use of an elevated crossing technically difficult. Fords can be used when it is not feasible to construct an elevated crossing however, the minimum requirement for fords must be implemented (see Fords section).

Minimizing Soil Use

MR 1.8 Avoid depositing soil into the stream or channel.

Regardless of the type of elevated crossing used, this minimum requirement emphasizes the importance of limiting the use of soil for in-channel fill. Soil placed into the stream or channel as fill around culverts or to support bridging can erode during use, is often difficult to effectively remove, and must be stabilized (see MR 1.9). Using poles as the primary filler around culverts or pipes is an example of implementing this requirement.

Crossing Selection for Temporary Logging Use

Table 8.1 provides a guide for elevated crossing selection based on stream type, presence of water, length of use and other factors.

Table 8.1. Guidelines for Elevated Crossing Selection

Crossing Type	Perennial Stream	Intermittent Stream		Ephemeral Channel	
	Any Season	Winter Spring ¹	Summer Fall ²	Winter Spring	Summer Fall
Bridge	✓	✓	✓	✓	✓
PVC Bundle	✓	✓	✓	✓	✓
Culvert/Pipe	✓	✓	✓	✓	✓
Hollow Log	✓	✓	✓	✓	✓
Pole Crossing			✓ ³	✓ ³	✓ ³
Tops/Debris					✓ ³

¹ Winter and spring—water is present or there is a high probability of occurrence.

² Summer and fall—water is not present and there is a low probability of occurrence.

³ Short duration use—decreasing the probability that water will be present.

Bridges

Bridges provide the maximum protection of water quality and the least disturbance to the stream and channel. Proper installation and attention to approaches and bank stability are critical to operational efficiency and protecting water quality. There are a wide variety of bridge options and selection is based on cost, availability, span and height of channel, logging equipment being used, operator experience, and safety concerns. Common bridging options are provided below.

Wooden Panel Bridges

Wooden panel bridges can be used for skidding, forwarding and hauling. They are composed of two or three panels placed side by side (Figure 8.1). Panel lengths are generally 18 to 24 feet with widths 4.5 feet to 6 feet. Panels are typically fabricated from 10- or 12-inch cants, often from lighter weight species, that are held together with threaded rods. They are easy to move, install and remove, and they are reusable. These factors along with facilitating fast cycle or drag times makes them economical and efficient (Figure 8.2).



Figure 8.1. Three panel wooden skidder bridge installation.



Figure 8.2. Wooden skidder bridge with bumper trees to assist in keeping loads behind the skidder while crossing the bridge.

Crane Mats

Crane and construction mats, similar to wooden panel bridges, can be used for crossings (Figure 8.3). While mats come in a variety of lengths, common lengths are often too short to span crossings and intermediate support is needed (Figure 8.4). Supports can be made from stacked crane mats or cants. To stabilize supports, drill holes and insert metal rods through mats into supports. While supports can be used, crossing locations should be selected that avoid their use when possible.



Figure 8.3. Crane mats installed over an ephemeral channel on a haul road.



Figure 8.4. Crane mats used for skidding across a perennial stream. Note intermediate span support.

Log Bridges

Logs can be lashed together for skidding and hauling (Figure 8.5). The following diagrams provide an example of a lashing design developed by Dick Brantigan for loggers in Kentucky (Figure 8.6). The lashing design is engineered to pull logs tight when the bridge is loaded avoiding separation, a common problem with other lashing designs. The design also helps distribute load to all logs, including outer logs, increasing load capacity.



Figure 8.5. Log bridge developed using recommended lashing design.

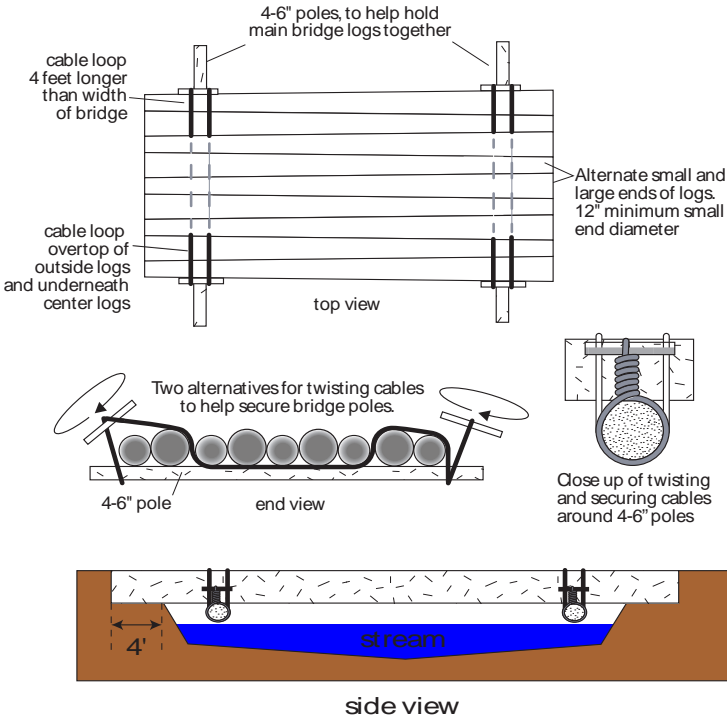

Figure 8.6. Lashing design for log bridges.

Metal and Wooden Plank Bridges

A number of bridging options including portable steel or aluminum bridging, truck and trailer chassis, and pole and lumber bridges can be used for hauling, skidding, and forwarding (Figure 8.7). Options that limit the amount of intermediate span support are preferred.



Figure 8.7. Aluminum truck bed modified for crossing use (a), and pole and lumber skidder bridge (b).

PVC Pipe Bundle

PVC pipe bundles are composed of schedule 40 PVC pipes held together with two steel cable loops. They are placed into streams or channels covering the entire bed (Figure 8.8).



Figure 8.8. PVC pipe bundle installed in ephemeral channel, folded over itself to ensure channel bed is covered and top pipe layer is flat across the top.

A geotextile or plastic sheet is placed over top of the bundle (Figure 8.9). Dirt, tops, wooden mats or a combination are placed on top of the bundle (Figure 8.10). The design protects the entire stream or channel bed. Removal is accomplished by pushing the majority of dirt from the top of bundle and extracting the bundle by hooking to and pulling the cable loops (Figure 8.11). PVC pipe bundles are one of the most cost effective methods for crossing small streams and channels. This is a result of their relatively low cost, as they can be reused, combined with the ease at which they can be removed and limited retirement costs often associated with them.



Figure 8.9. Bundle covered with geotextile and ready for covering with dirt or other material.



Figure 8.10. Approximately 1 to 2 feet of dirt was placed on top of bundle before skidding.



Figure 8.11. After use, dirt is pushed off of bundle and bundle is pulled from channel. This often results in any remaining covering material to be deposited onto or above the bank.

Culverts and Pipe

Culverts (corrugated steel, single or double walled plastic) and steel pipe are readily available and commonly used for crossings (Figure 8.12). However, they require a significant amount of backfill in the channel and if soil is used, the soil can be difficult to remove with logging equipment. Minimum requirement 1.7 requires avoiding the use of soil for crossings. Where possible, poles can be used to fill around culverts or pipes instead of soil (Figure 8.13).

Proper sizing and installation is important to minimize the restriction of water flow. Table 8.2 provides sizing guidelines for corrugated pipe based on the acreage being drained.



Figure 8.12. Culverts are one of the most common crossings used for skidding and hauling.



Figure 8.13. Poles used to fill around pipe avoiding depositing soil into stream or channel.

Table 8.2. Recommended Pipe Diameters for Streams and Ephemeral Channels

Area above Pipe (acres)	Pipe Diameter (inches)
2	12
4	15
7	18
12	21
16	24
27	30
47	36
64	42
90	48
120	54
160	60
205	66
250	72
350	78

Culverts and pipes should be in contact with the channel bed. Pack backfill around bottom of culvert and cover with at least one foot of backfill to prevent crushing (Figure 8.14).

The culvert or pipe should extend at least one to two feet on either side of road or trail (Figure 8.15). Placing stone on the upstream side can help longevity of the crossing and reduce muddy water during high flows.

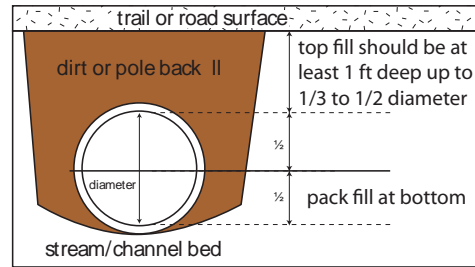

Figure 8.14. Proper culvert or pipe installation.

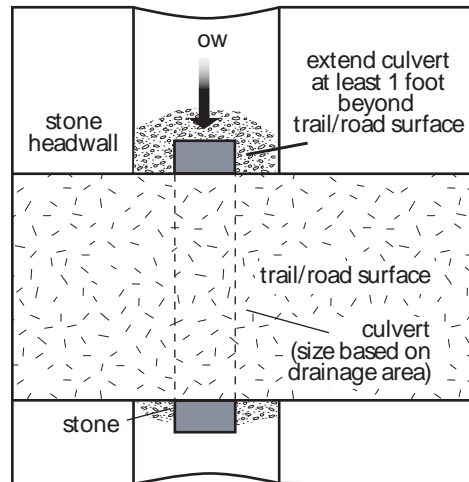

Figure 8.15. Proper culvert depth, back filled with dirt, poles, or tops.



Figure 8.16. Hollow logs should provide the largest opening possible (a). Ensure that the hollow extends the entire length of the log and plunge cutting can be used to improve size of opening where needed (b).

Hollow Logs

Hollow logs can be used as an elevated crossing. Guidelines for use are similar to those for culverts and pipes. The hollow logs should be sized appropriately, installed on the bed, and long enough to extend 1 to 2 feet beyond the width of the road or trail. The hollow should extend the entire length of the log(s) and the end with the smallest opening should be upstream to help decrease the potential for clogging (Figure 8.16).

Pole Crossing

Pole crossings can be used effectively for skidding or forwarding across small ephemeral channels or intermittent streams during the dry season (Figure 8.17). For deeper channels consider placing cable under poles to facilitate removal.



Figure 8.17. Pole crossing used for skidding across an ephemeral channel during the dry season.

Debris and Tops for Crossings

When ephemeral channels need to be crossed for very short periods of time during the dry season tops and branches can be used for elevated crossings (Figure 8.18). As with other crossing types keep the use of soil to a minimum. Because this crossing is functionally a blockage of the channel it must not be used when there is a likelihood of flowing water and it must be removed as soon as possible.



Figure 8.18. Tops used to cross a small ephemeral channel skidder crossing during the dry season.

Fords

MR 1.7 If it is not feasible to install an elevated crossing **FORDS** with firm and/or protected stream or channel beds shall be used to cross streams and channels at right angles. Avoid depositing soil into the stream or channel.

Fords can be used to cross streams and ephemeral channels when elevated crossings are not feasible to install. In some instances fords can be the preferred option when they would cause minimal water quality impacts compared to elevated crossings.

To correctly install fords:

- locate where stream banks are low
- firm beds are required with solid rock or gravel
- if needed install materials to increase stability of bed (crushed rock, poles, crane mats). Make sure to not significantly alter bed height.

Where possible locate fords on a natural rock bed (Figure 8.19a). Soft beds of dirt and mud are not permitted (Figure 8.19b). In these cases, rock or other material such as poles must be used to stabilize the bed.



Figure 8.19. Stream with natural rock bed used as a skidder crossing (a). Fords with soft beds are not allowed and poles or other materials must be used to provide proper flotation on stream or channel beds (b).

Skidding across fords can be particularly problematic as dirt is continually drawn into the channel. This problem increases with bank height. Attention must be paid to stabilizing the approach and minimizing bank heights. For haul roads, gravel and other materials can be used to armor the road leading down to the bed (Figure 8.20).



Figure 8.20. Gravel can be used to armor approaches of fords used for hauling.

Stabilizing Crossings

MR 1.9 Immediately stabilize disturbed ground associated with crossings (excluding the active trail or road surface) to reduce runoff into streams.

Construction of elevated crossings and fords creates disturbed ground that can wash into channels and streams. Crossing types that involve significant soil fill, which is common with culvert and pipe crossings, are particularly prone to generating muddy water.

Disturbed soil must be stabilized during construction or as soon as the crossing is completed. There are a number of ways in which this can be done. The most common is the use of mulch and seeding. Seed that will germinate and establish ground cover quickly (ex. winter wheat) is recommended (Figure 8.21). Other materials can also be used to stabilize fill including poles, cement sacks and other materials (Figure 8.22).



Figure 8.21. This skidder crossing using a culvert was immediately stabilized with mulching and seeding with a mix of winter wheat and fescue.



Figure 8.22. Sacks of concrete used to stabilize fill.

All crossings have three sources of muddy water that must be controlled as much as possible (Figure 8.23):

- runoff from road or trail surfaces beyond the approach
- disturbed soil from construction
- erosion of the bank and/or approach.

MR 1.9 focuses on the disturbed soil from construction. MR 1.2 requires that the runoff from upslope road and trails surfaces be controlled. Controlling erosion from approaches and banks is recommended and may be required for some Exceptional Use Waters.

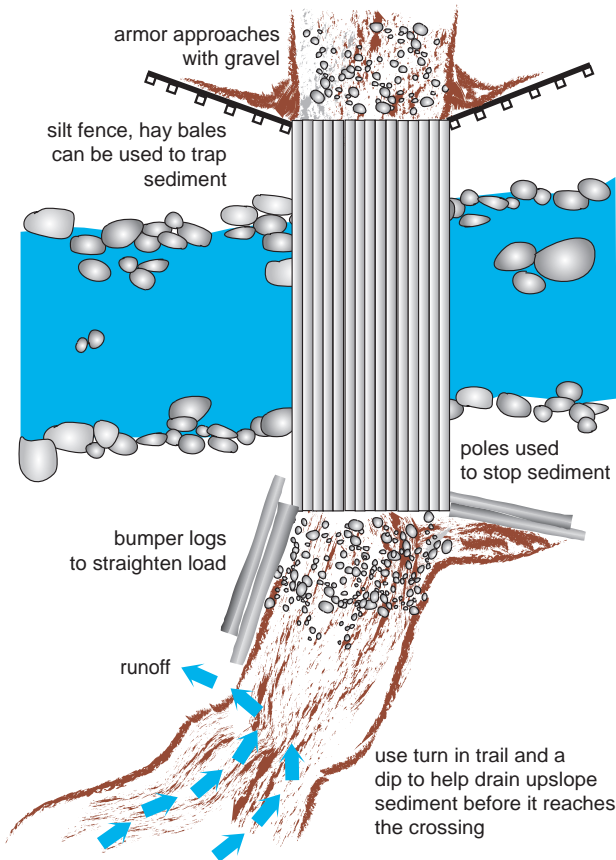

Figure 8.23. Sources of sediment associated with crossings.

Removal and Retirement

Temporary crossings must be removed as a part of retirement practices (MR 1.10). See Retirement section for details.

Chapter 9

Haul Roads, Trails, and Landings— Construction, Use and Maintenance

- MR 1.1** ACCESS ROADS and TRAILS shall be constructed to minimize grade.
- MR 1.2** To avoid runoff from entering STREAMS or CHANNELS access roads and trails shall be located, constructed, maintained and WATER CONTROL STRUCTURES installed at appropriate intervals to drain surfaces, reduce erosion of road and trail surfaces and the undisturbed forest floor.
- MR 1.3** LANDINGS shall be constructed to drain and avoid runoff from entering streams or channels.
- MR 1.4** Skidders or other logging equipment shall not be operated under conditions that may cause the development of ruts that contribute to water quality degradation and cannot be resurfaced with AVAILABLE EQUIPMENT.

Grade

- MR 1.1** ACCESS ROADS and TRAILS shall be constructed to minimize grade.

The minimum requirement allows flexibility in building roads and trails. However, as steepness increases so does the potential of erosion to road and trail surfaces that can increase the potential for pollution. Haul roads are less of an issue than trails, as grades must be minimized on haul roads to allow efficient truck movement. It is recommended to keep road grades less than 15 percent slope with short stretches that can exceed this. Skid trails can be more of a problem as slopes can be significant and water is more difficult to control on active skid trails than it is on haul roads. Therefore minimizing slope of skid trails, particularly when approaching a stream or operating close to water, helps with reducing the potential of sediment reaching streams.

Location and Requirements for Streams, Sinkholes, Wetlands

The location of roads, trails, and landings must adhere to minimum requirements for Streamside Management Zones, Sinkholes, and Wetlands (see Streams and Channels, Sinkholes and Wetlands). Location must also consider keeping runoff out of drainage channels, ditches or other areas that will indirectly carry runoff to streams, other water bodies, or sinkholes.

Landings

Landing Construction

MR 1.3 Landings shall be constructed to drain and avoid runoff from entering streams or channels.

If landings are located where runoff cannot reach streams or channels they may not require measures to control runoff. However, when landings are located in close proximity to water or ephemeral or drainage channels, for example roadside ditches that drain into a stream or into another channel that leads to a stream, the landing must be constructed to keep the muddy water runoff out of the stream. Also when landings are directly adjacent to streams and channels, inside the SMZ because there is no other feasible location, care must be taken to keep cutoffs (Figure 9.1) and mud (Figure 9.2) from being inadvertently pushed over the bank.



Figure 9.1. Landing located directly adjacent to a small stream resulting in cutoffs and other debris in the stream.



Figure 9.2. To reduce mud on the landing, soil was pushed into a small headwater stream.

The following will minimize the amount of sediment reaching streams and sinkholes.

- Slope to drain runoff away from streams and channels.
- Drain roads and trails leading down into a landing so that water does not run onto the landing.
- Construct so that runoff does not flow from a landing down a road or trail that leads downslope to a stream or channel.
- Where there is a possibility of runoff directly or indirectly entering streams or sinkholes use a vegetative (grass) filter strip, straw bales, berms, silt fence, or other techniques to keep runoff out of these areas.
- During construction do not push soil or other debris over banks or into sinkholes.

Landing Maintenance and Use

Landings are the center of the logging operations and are heavily used throughout the entire operation.

- Logging debris, including cutoffs, limbs and tops are generated at landings. Leveling can generate disturbed soil and at times mud needs to be cleared. Debris, soil, and mud can be pollutants and care must be taken to keep them out of streams and channels (see minimum requirements in Streams, Sinkholes and Wetlands section).
- Fuel and other fluids are stored and used, and trash is generated, on landings. Minimum requirements for these pollutants must be adhered to (see Fluids and Trash section).

Roads and Trails

MR 1.2 To avoid runoff from entering STREAMS or CHANNELS access roads and trails shall be located, constructed, maintained and WATER CONTROL STRUCTURES installed at appropriate intervals to drain surfaces, reduce erosion of road and trail surfaces and the undisturbed forest floor.

To avoid excessive muddy water runoff reaching streams and channels, haul roads, and skidder and forwarder trails, must be:

- located and constructed properly
- water control structure or measures installed appropriately
- maintenance of road and trail surfaces and water control structures is required to ensure their effectiveness.

This requires planning and layout decisions and monitoring during use.

Location

Locations of roads, trails, and landings must adhere to Streamside Management Zone minimum distances and Sinkhole requirements (see Chapter 7). Regardless of whether they are near a stream or sinkhole, roads and trails must be located so as to reduce or eliminate the chance that muddy water runoff reaches streams, ephemeral channels, man-made ditches and other drainages that empty into streams. Figure 9.3 shows a skid trail running directly from a landing straight downslope across a small stream. The location of the trail makes it extremely difficult to keep runoff from entering the stream while the trail is actively being used. Proper use of BMPs requires that the trail should have not been constructed in this location and may require relocation.



Figure 9.3. Poorly located and constructed skid trail resulting in muddy water running directly into a small stream.

Construction, Water Control Measures and Maintenance

Along with location, initial construction and the installation of water control measures or structures is critical to avoid muddy water reaching streams and channels.

Seeps and Low Points on Roads and Trails

There are two situations that require special attention; seeps and low points on roads and trails. When seeps are encountered some type of structure should be used to ensure that the water from the seep does not build up on the trail or road. Culverts and pipes, installed at or near seeps, are normally the best option to keep seep water off the road or trail surface (Figure 9.4).

Low points can occur on both roads and trails. Runoff accumulating from two directions can result in a significant amount of muddy water building up at one spot. This buildup increases

the distance that the runoff can move downhill, thus increasing the potential for pollution (Figure 9.5). Water control structures should be built on either side to reduce runoff accumulating in the low point. Materials, such as poles or rock can also be placed in the low point.



Figure 9.4. Seeps represent special situations that should be cross drained under the road with a culvert, pipe, or hollow log.



Figure 9.5. A low point in a skid trail accumulating runoff from both directions leading to erosion and gully formation.

Water Control Structures— Haul Roads

There are a large number water control structures that can be used on haul roads to prevent the buildup of runoff and to drain the haul road. Design and build roads to remove water from road surfaces and keep roads dry and structurally sound. Three common road designs include: crowned, out-sloped, and in-sloped (Figure 9.6).

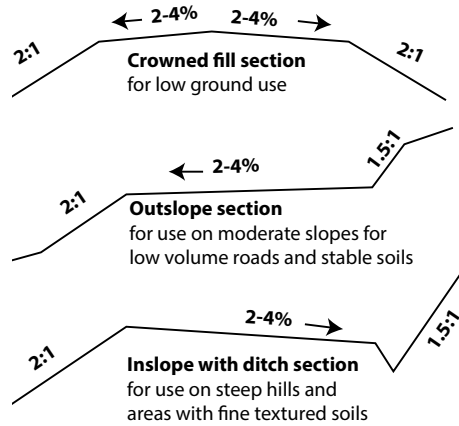

Figure 9.6. Common haul road cross-sectional designs.

Crowning and Out-Sloping

Crowning and out-sloping are used to continuously carry water off the road. Crowning roads are typically used in relatively flat terrain. Out sloping, usually 1 to 2 percent, is a drainage technique where the road is sloped toward the outside (downslope) side of the road. Use this technique on roads with moderate gradients and stable soils. Out-sloped roads can be hazardous when slick and in steep topography.

In some cases roadside ditches along with turnouts or lead-off ditches (Figure 9.7) are required to carry water from crowned or out-sloped roads so as to drain safely into the forest before reaching streams or drainage channels. Build diversion ditches to avoid ponding and use Table 9.1 as a spacing guideline.



Figure 9.7. Turnouts or diversion ditches can be easily constructed to drain haul roads.



Figure 9.8. A well-constructed haul road, with gravel in-sloped surface and seeded ditch.

In-Sloping and Cross Draining

In-sloping is a technique where the surface is sloped toward the inside or uphill side of the road. The runoff is carried in a ditch where cross drain structures (culvert or pipe, broad-based dip) are installed at appropriate intervals to move the water from the ditch across or under the surface to the undisturbed forest floor (Figure 9.8).

Cross Draining— Broad-based Dips

Broad-based dips are the most common structure used to drain haul roads (Figure 9.9). These are constructed by cutting below the compacted road surface and building a gentle hump that can be safely and efficiently driven over by loaded

Table 9.1. Recommended Distances between Drainage Control Structures for Access Roads

Road Grade (%)	Spacing (slope distance in feet)
2-5	300-500
6-10	200-300
11-15	100-200
16-18	100

Note: Deviations from these recommendations may be appropriate depending upon the nature of the road surface material and its erodibility.



Figure 9.9. Older broad-based dip constructed on an unimproved haul road (a), newly formed broad-based dip showing runoff moving across angled dip (b).

trucks. They are referred to as reverse grade structures because the hump reverses the slope of the haul road stopping runoff from continuing down the road (Figure 9.10 and 9.11). The structure is angled across the road to ensure that it drains. Armoring the hump and dip with gravel decreases maintenance.

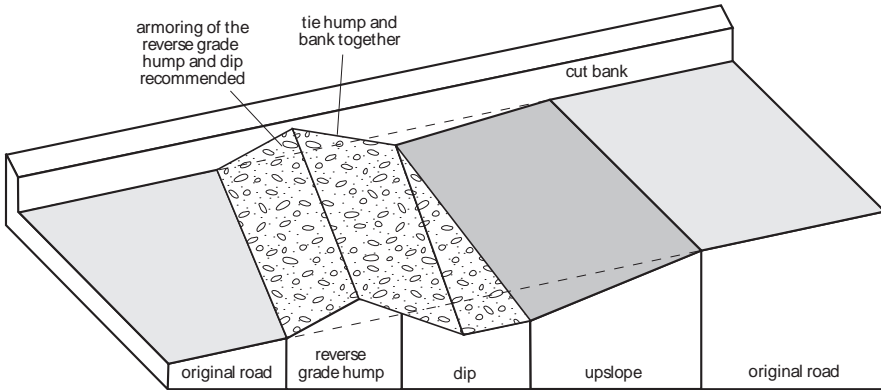
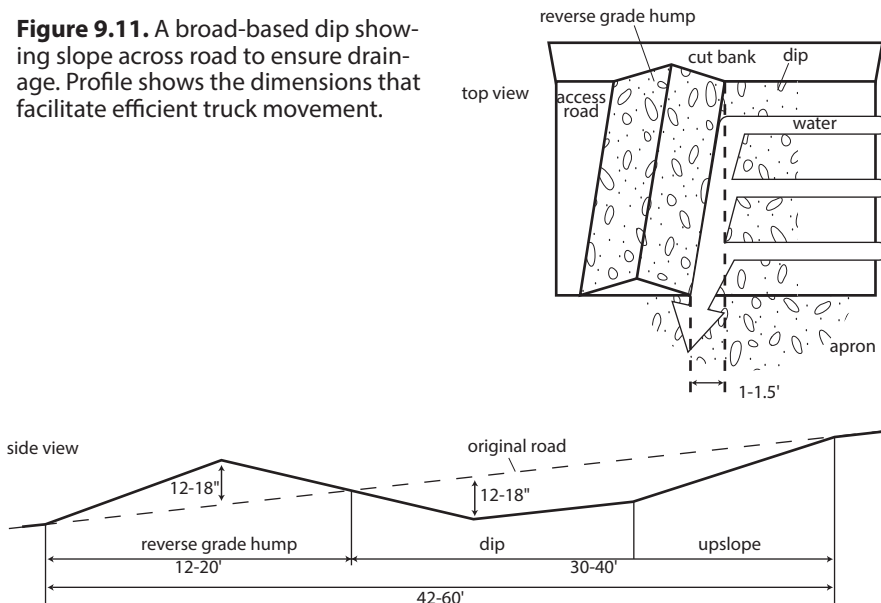

Figure 9.10. Reverse grade structure showing angled hump and dip.

Figure 9.11. A broad-based dip showing inverse slope across road to ensure drainage. Profile shows the dimensions that facilitate efficient truck movement.



Note: These drawings are not drawn to scale.

Cross Draining—Culverts

Steel corrugated culverts or single or double walled plastic culverts can be used to drain in-sloped roads (Figure 9.12). Steel pipe and hollow logs can also be used.



Figure 9.12. Corrugated steel culvert used to cross drain the ditch on an in-sloped haul road.

Culverts, pipes, or hollow logs must be installed properly, including at the proper angle to work effectively at draining the in-slope ditch (Figure 9.13). Placing rock at the outlet of culverts can be effective in reducing downslope erosion. This is especially true when the outlet of the culvert is off the ground or the slope is steep (Figure 9.14).

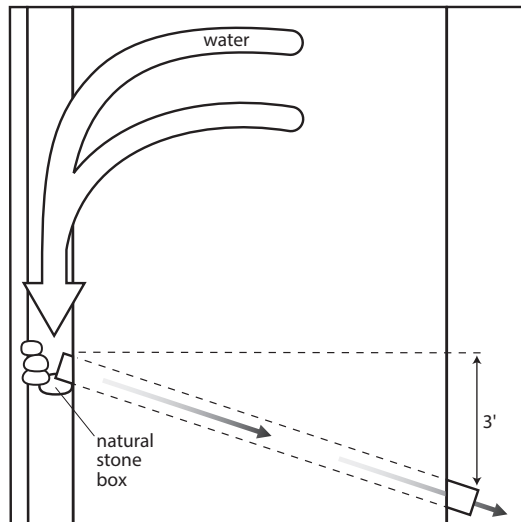

Figure 9.13. Top and side view diagram of culvert used to drain in-slope ditch.

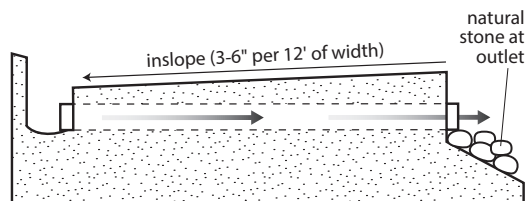



Figure 9.14. Rock used to reduce gully erosion from forming directly below a culvert outlet.

Spacing and Location of Cross Drain Structures—Haul Roads

Table 9.1 provides spacing of cross drain structures including broad-based dips, culverts, and other similar structures on haul roads. The spacing is based on slope percent of the haul road and ensures that the runoff does not remain on the road long enough to significantly erode the surface. These intervals also help reduce the amount of runoff being discharged. This reduces the potential to create gully erosion of the forest floor and limits the distance that the muddy water moves down slope.

Cross drain structures should be constructed at appropriate intervals. However, their placement should avoid emptying into streams, channels, or ditches that run into streams (Figure 9.15).

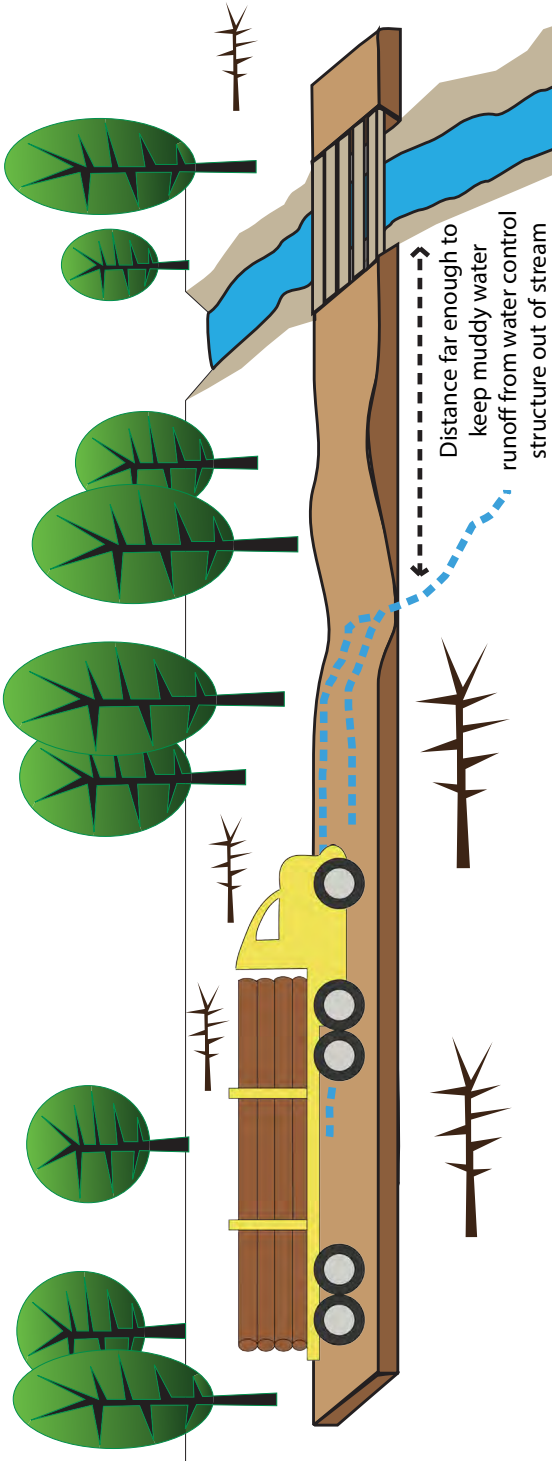

Figure 9.15. Water control structure located so that runoff does not reach stream.

Use of Mats on Roads and Landings

There are conditions where mats (typically wooden) can be used to protect landings and haul roads, minimize erosion, and help prevent water pollution (Figure 9.16). Mats can also help increase productivity, reduce equipment wear, and help keep mud off highways.



Figure 9.16. Wooden mats, made specifically for logging or for use in construction can be effectively used for haul road protection.

Water Control—Trails

Construction of trails includes measures or structures to keep them drained and avoid runoff from reaching streams or channels. A number of different techniques can be used to properly drain active trails including:

- out-sloping to keep muddy water continuously draining off the trail surface
- turns periodically placed in the trail to help water drain from the surface (Figure 9.17)
- removing berms created during construction to allow surfaces to drain
- cross drain structures such as hollow logs or pipes placed under and across the trail where water accumulates on the uphill side or where seeps occur
- draining trails so that runoff does not accumulate from both sides of a low point
- water control structures used for haul roads can at times be used on forwarder trails
- monitoring and maintaining water control structures and berms to ensure water is draining at desired locations.



Figure 9.17. Skid trail placed with curves or turns where water can easily run off the surface.

Rutting

MR 1.4 Skidders or other logging equipment shall not be operated under conditions that may cause the development of ruts that contribute to water quality degradation and cannot be resurfaced with available equipment.

While trails and roads can be constructed to drain properly, rutting can degrade them and stop water control structures like broad-based dips, out-sloping and in-sloping from working properly. It is recognized that rutting may easily occur in wet weather conditions. However, loggers are responsible for ensuring that rutting can be controlled to meet the minimum requirement (Figure 9.18).

The requirement indicates that operations must be adjusted if ruts are being produced or there is a potential for rut production that will potentially lead to muddy water reaching streams or channels. If equipment is available to fix ruts, operations may continue while ruts are being fixed. If equipment is not available (meaning on-site) then operations must cease until equipment is brought to the site and ruts are fixed or are in the process of being fixed.



Figure 9.18. A rutted skid trail typical of operations during wet weather, requiring attention if runoff can potentially reach a stream or channel.

Temporarily Inactive Roads, Trails, and Landings

MR 1.10 On roads, trails, and landings that are temporarily inactive practices shall be promptly implemented to minimize erosion and runoff entering streams or channels.

Temporarily inactive refers to:

- entire jobs where timber must still be cut and hauled but equipment necessary to cut, move and load timber has been moved off-site for over 14 days
- roads, trails, and landings on an active logging site where hauling or loading has ceased for over 14 days
- logging sites where cutting, skidding, and hauling is finished but there will be period of time before final retirement work is completed.

On temporarily inactive roads, trails, and landings sufficient use of water control measures should be implemented to prevent muddy water runoff from entering streams or channels for the period of time that they will be inactive. This could include strategically placing a limited number of water control structures to keep runoff out of water or channels while the site is inactive. For example, placing several water bars where a skid trail is crossing a stream. Temporary water control measures that are not as robust as permanent structures could also be installed if left only for a short period of time (Figure 9. 19).



Figure 9.19. Temporary water control structures on a skid trail that will be in place for two weeks before final retirement work will be implemented.

Chapter 10

Disturbed Ground Other Than Roads, Trails and Landings

MR 1.5 Practices shall be implemented to control erosion that can deliver sediment to streams or channels from disturbed ground other than roads, trails, and landings.

While roads, trails and landings contain the majority of disturbed soil, there can be other areas where operations can expose soil to erosion. This minimum requirement indicates that practices used to prevent runoff from reaching streams should be used on these areas. The most common practice is to seed and use methods to help ensure revegetation.

Chapter 11

Fluids and Trash

- MR 5.1** Equipment fluids shall not be drained onto the ground and should be collected, transported off site and disposed of properly.
- MR 5.2** Equipment shall not be left on or adjacent to stream banks.
- MR 5.3** All TRASH shall be properly disposed of off-site.

All equipment has the potential to leak fluids and should be parked so that fluids cannot reach streams and other waters, channels, ditches, or sinkholes. Significant leaks from equipment should be repaired or equipment removed from the site. Loaders and bucksaws are particularly prone to leaks that can accumulate fluids and special attention should be paid to the location of this equipment to avoid streams and channels.

All logging operations also generate trash (Figure 11.1). Used and discarded parts are common to logging operations as are discarded personal items. All of these need to be disposed of off-site in a timely manner.



Figure 11.1. Trash and fluid containers commonly found on logging operations.

Chapter 12

Retirement—Roads, Trails, Landings

MR 1.11 Upon completion of harvesting activities PERMANENT RETIREMENT PRACTICES shall be implemented on roads, trails, and landings and other areas of disturbed ground to minimize erosion and runoff from entering streams or channels. Permanent retirement practices include the use of appropriate practices including:

- resurfacing
- removing berms and other impediments to allow drainage
- correct installation of permanent water control structures to drain surfaces and minimize erosion
- removal of temporary stream and channel crossings
- seeding and measures to promote the development of vegetative cover (see BMP 2) that may include one or more of the following; loosening compacted soil, fertilization, mulching, or liming.

This minimum requirement is to be implemented on areas that can produce muddy water runoff that has the potential to cause pollution. This includes runoff that can directly or indirectly enter streams. The latter typically occurring through ephemeral channels or ditches. For roads, trails, and landings located in areas that will not contribute to pollution, loggers have discretion on what retirement practices are used.

When and Where Retirement Practices Are Required

When logging is completed on an entire site, or a section of a site, permanent retirement practices are required on roads, trails and landings that can generate muddy water that has the potential to reach streams or ephemeral channels (Figure 12.0). These practices are required to be implemented as soon cutting, skidding, and hauling are completed. If weather and soil conditions preclude correct implementation of permanent retirement practices, then follow minimum requirement 1.10 for a temporarily inactive site. This will stabilize the area until permanent retirement can be accomplished.

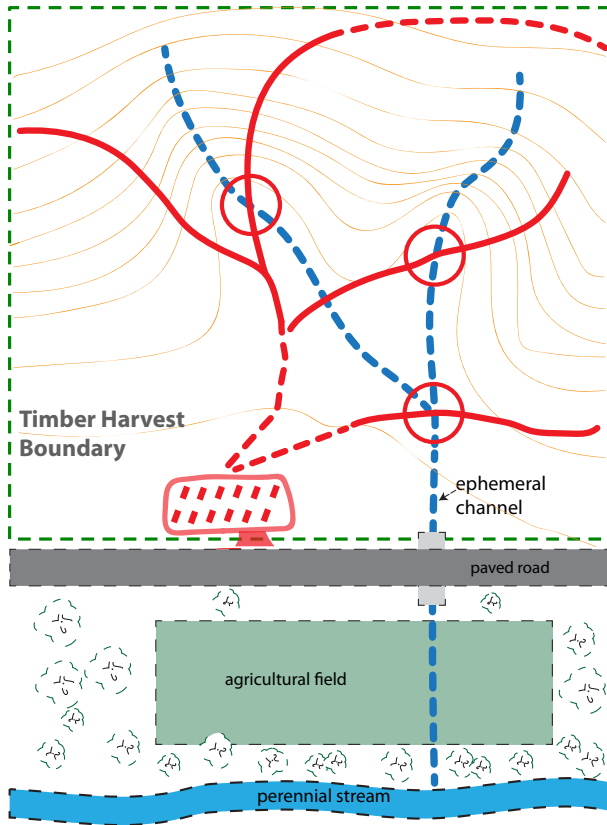

Figure 12.0. Areas in the logging operation that need retirement are delineated with a solid red line because muddy water from these sections of trails can reach the perennial stream through the ephemeral channel network. Special attention is needed to the circled crossing locations. Dashed red skid trail sections and the log landing would not need retirement as they do not drain into the ephemeral channels. Note that if a roadside ditch was present, leading to the ephemeral channel, the landing would most likely need to be retired.

Retirement Practices

Haul Roads and Landings

In many cases haul roads will have water control structures in place and retirement may require smoothing ruts, refurbishing structures, and other provisions that the landowner may require. Remember that minimum requirements are only required for areas that may result in muddy water directly or indirectly reaching water bodies. However, there are many instances when landowners require more retirement practices than those required for BMP compliance. Unless gravelled, revegetation is commonly required. This includes seeding and using practices to promote revegetation such as seeding into loose soil or using fertilizer, lime and mulch (see Seeding Practices section). In some cases, the landowner may wish to reclaim these areas and this can be verified during inspections.

Trail Retirement

When skidding or forwarding is completed, permanent water control structures should be implemented on trails that can potentially lead to muddy water, directly or indirectly, reaching streams. There are a number of options for retiring trails, including trails that will not be used again or those that the landowner wishes to continue to use. For the latter see Landowner section below. Alternatives include:

- water control structures used for haul roads (for trails that will continue to be used)
- water bars
- skidder bars
- embedded tops
- out-sloping
- re-contouring to the original slope
- poles, straw bales and other special structures.

Water Control Structures for Skid Trails

Water Bars

Water bars are the most common and often cheapest water control structures to use for retirement. They can be efficiently constructed with a bulldozer (Figure 12.1). They are reverse grade structures with a hump that is 2 to 3 feet tall and a dip that is cut below the surface of the trail (Figure 12.2). The hump is tied into the cut bank or uphill side of the trail. It should be angled so the outlet is 3 feet below the uphill side of the hump.

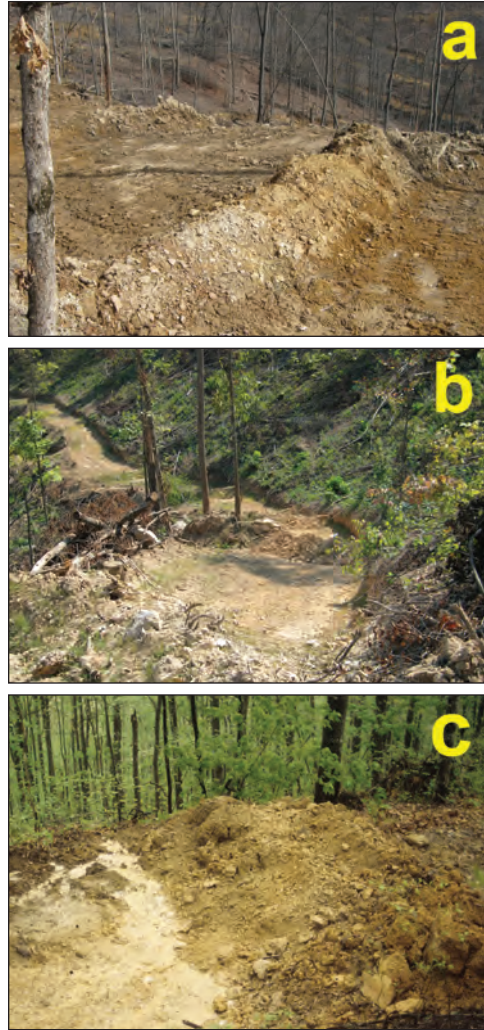
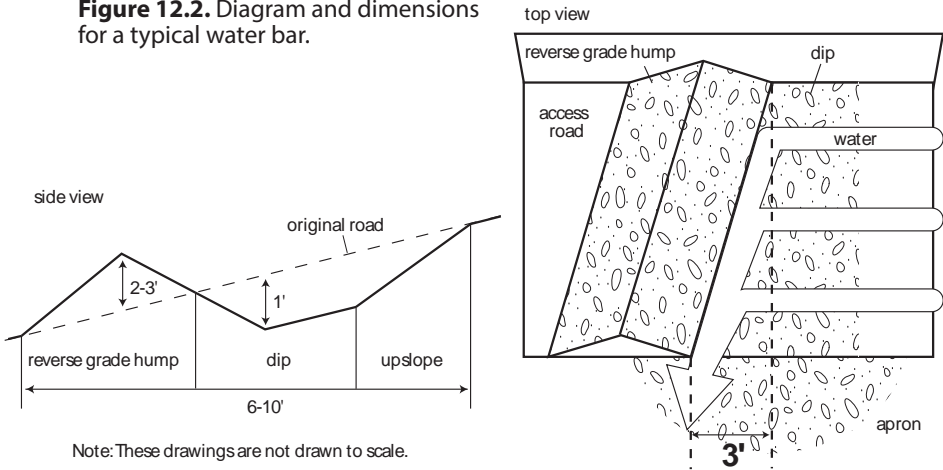

Figure 12.1. Water bars can be easily constructed using a dozer with a 6 way blade, across wide (a) or narrow (b) trails, and are constructed so that water drains easily from the structures (c).

Figure 12.2. Diagram and dimensions for a typical water bar.



The most common problems with water bar construction (Figure 12.3) include:

- not tall enough
- built straight across the trail or reversed to trap runoff
- hump and dip not extending to the edge of trail
- dip blocked
- built U-shaped with a skidder.

These problems typically result in a failure of the structure. This leads to continued flow down the trail and increased erosion and muddy water runoff.

Figure 12.3. Examples of incorrectly constructed water bars including water bars that are small and or straight across the trail (a), lower end blocked (b), and a skidder built structure that created ponding (c).

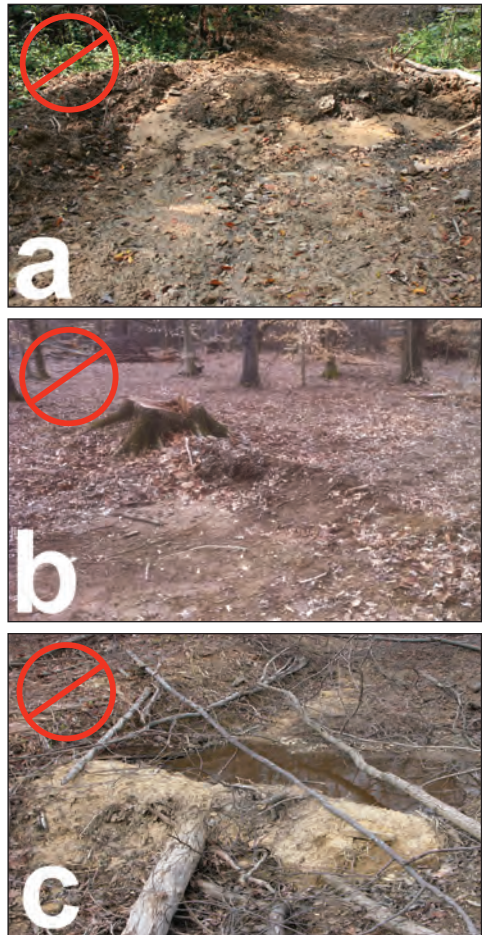

Skidder Bars

Skidder bars were developed as an alternative water control structure that can be easier to install with a skidder than constructing a traditional water bar. Skidder bars are constructed by making a series of overlapping piles of dirt scraped up using the skidder blade. The skidder bar is large enough to stop the downward flow of runoff and is angled across the trail so that the structure drains easily (Figure 12.4). The design in Figure 12.5 shows the arrangement of the piles and the order in which they are constructed with a final blade push that ensures the outlet of the structure is not blocked.

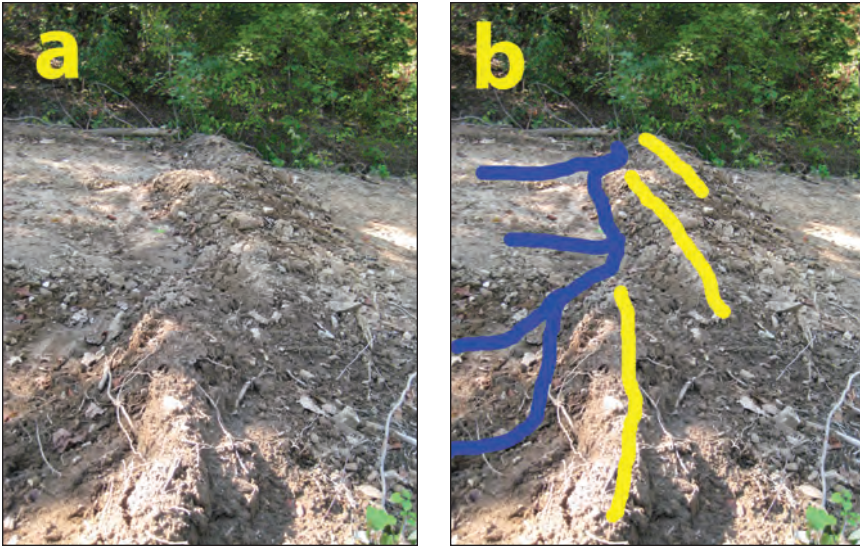

Figure 12.4. Skidder bar showing 3 overlapping piles (a) creating a structure that is angled across the road with the outlet lower than the inlet allowing water to easily drain (b).

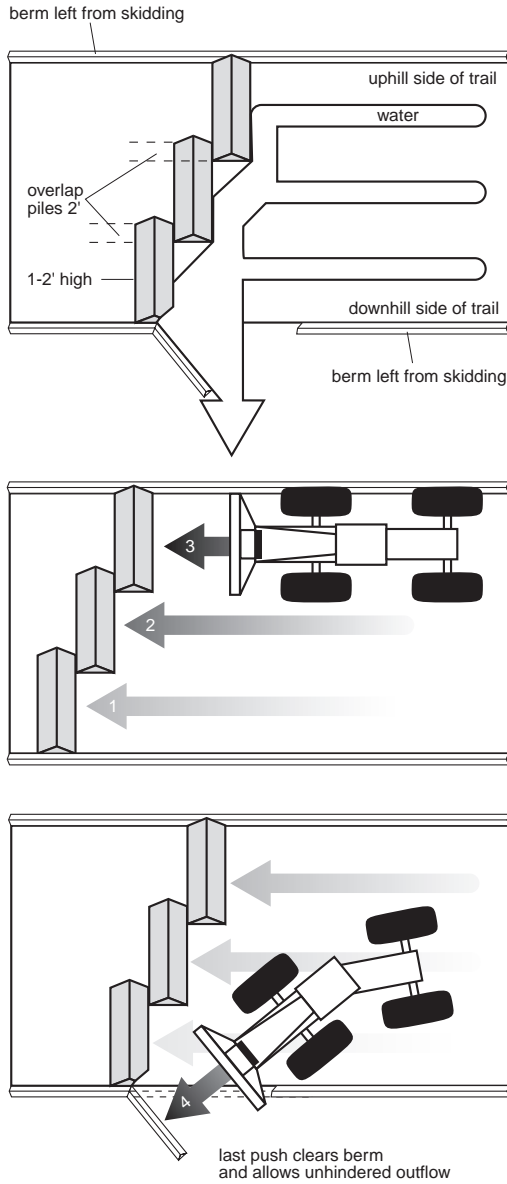

Figure 12.5. Skidder bar construction sequence.

Spacing of Water Control Structures

Water and skidder bars and other cross drain structures should be spaced appropriately to:

- minimize the buildup of runoff and erosion of the surface
- minimize the accumulation of runoff that could erode the undisturbed soil directly downslope from the outlet.

Table 12.1 provides appropriate distances between cross drain structures. Location and spacing must also avoid runoff from entering streams, ephemeral channels and drainage ditches.

Table 12.1. Distances¹ between Permanent Cross Drain Water Control Structures

Slope Percent	Spacing (slope distance in feet)
1	400
2	245
5	125
10	78
15	58
20	47
25	40
30	35
35	32
40	29

¹ Actual distance will depend upon the nature of the road surface material, its tendency to erode, and areas such as seeps.

Embedded Tops

Tops can be used as a water control structure if they can be sufficiently embedded in the trail surface. Normally a mechanized harvester can generate tops of sufficiently small size, place them onto the trail, and then track over them to embed them in the surface (Figure 12.6). Placing tops on a trail and not embedding them is not sufficient to control erosion. Runoff can easily continue under and around tops resulting in erosion and gully formation. Using tops in this manner is not considered a water control structure or practice.



Figure 12.6. Tops generated from a mechanized harvester in a hardwood stand (a) and a pine plantation (b).

Out-Sloping

Out-sloping can at times be efficiently used, particularly when the trail is naturally out-sloped across its entire width or a portion of it.

Re-contouring

Re-contouring the slope is an option that can be used to drain retired trails, but it is often time consuming and it can be difficult to generate enough fill dirt to re-contour over a long distance.

Other Structures

Other materials such as hay or straw bales that are staked to the ground, silt fence, or a used conveyor belt can be used as a water control structure. Poles can also be dug into the ground and used as water control structures (Figure 12.7). These alternatives are typically used only in special cases where trying to build structures with heavy equipment is difficult, time consuming or only a limited number are needed.

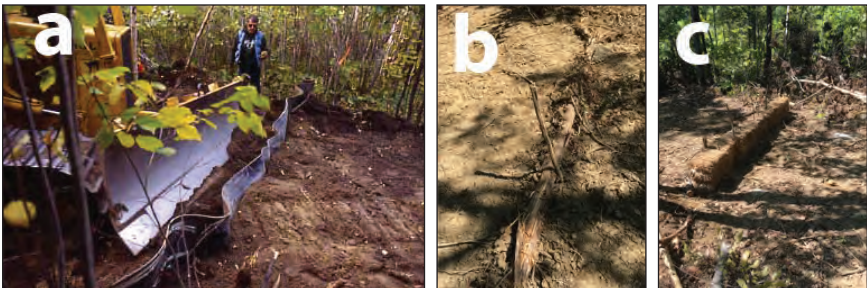

Figure 12.7. Alternative water control structures for trails using a used conveyor belt angled across the trail (a), a cedar pole dug into the trail surface (b), and staked straw bales (c).

Trails Not Requiring Retirement

There are situations when skidding or forwarding may not create enough bare ground to lead to erosion and potential pollution. For example, skidding one load across relatively flat ground may disturb undergrowth but not expose a significant amount of soil. The same applies to forwarding.

Both are referred to as paths and if they are not generating or are unlikely to generate runoff, they do not need to be retired (Figure 12.8).



Figure 12.8. Skidder path where limited skidding has not created sufficient bare ground to require retirement.

Landowner Options—Roads and Trails Remaining Open for Landowner Use

When landowners desire roads or trails to remain open for their use water control structures must be used that will meet their needs. This can include water control structures used for haul roads that will allow vehicles to use the trail without difficulty. Figure 12.9 is an example of a small broad based dip armored with gravel that was used for retiring a trail.



Figure 12.9. A small reserve grade structure with gravel on a retired haul road. The size, with the addition of gravel, is sufficient to handle light traffic by the landowner.

Structures like open topped pole or box culverts (Figure 12.10), typically not feasible to use on heavily trafficked haul roads, can be used and may be more compatible with landowner use. However, they are expensive to install. (Figure 12.11 and 12.12).



Figure 12.10. Box culvert used on retired and compacted haul road.

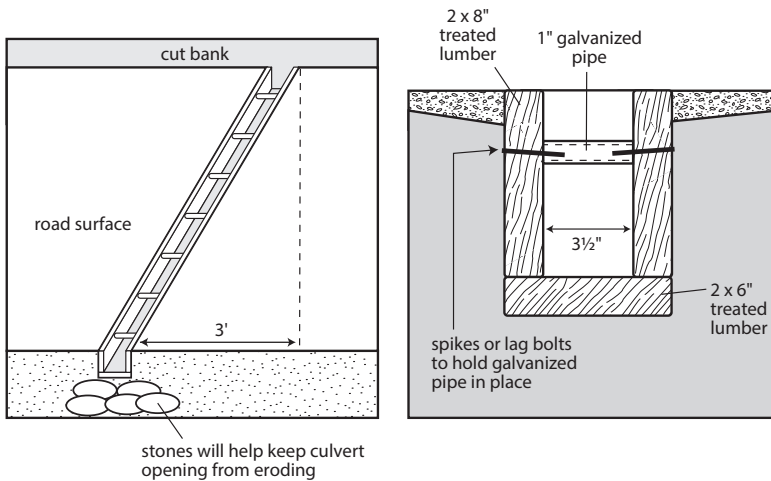
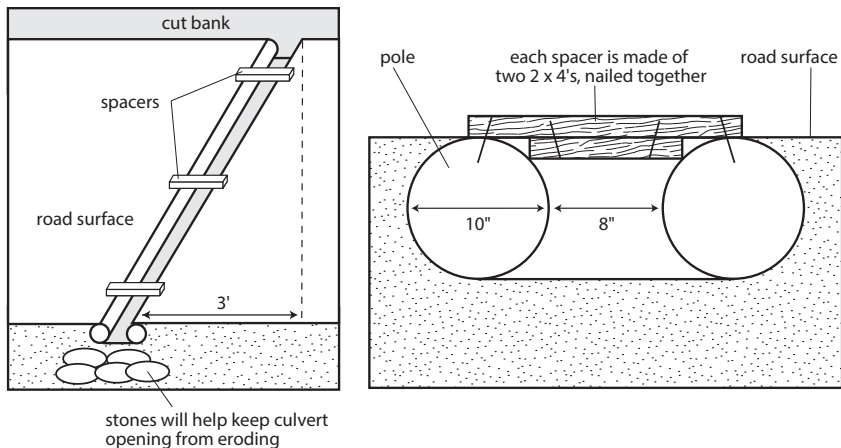

Figure 12.11 (above) and **12.12** (below). Open topped box and pole culverts allowing for easy trafficking by landowners.



Crossing Removal and Retirement

MR 1.11 ... PERMANENT RETIREMENT PRACTICES include the ... removal of temporary stream and channel crossings.

As part of retirement, stream and channel crossings should be removed and retirement practices used to stabilize the crossing site (Figure 12.13) including:

- removal of structure
- soil and/or debris used as fill removed from the stream or channel
- disturbed soil after removal should be stabilized with proper seeding practices and/or poles or other material to keep fill out of streams.
- permanent water control structures installed on trails and roads to keep runoff from reaching the crossing location.



Figure 12.13. Crossing was removed and fill soil was back dragged from the stream and seeded (a). Water control structure was placed directly above the approach so that runoff from skid trail did not wind up in the stream (b).

Seeding Practices

MR 1.11 ... seeding and measures to promote the development of vegetative cover (see BMP 2) that may include one or more of the following; loosening compacted soil, fertilization, mulching, or liming.

All retired areas require seeding and measures to promote the development of vegetative cover. The objective of proper seeding practices is to quickly produce vegetative cover that reduces erosion and allows the disturbed soil to settle.

Seed Mix

Selecting the proper seed mix based on soils, moisture availability, and time of year improves the potential for revegetation. Landowners often have interest in wildlife and landings can be used for establishing food plots and wildlife friendly ground covers. However, preventing water pollution is the objective of the BMPs. Seed mixes that meet this objective and can be effectively seeded by loggers and BMP contractors should be used.

While the minimum requirement does not specify the type of seed used, the most effective are a combination of a grass and a small grain cover crop. Examples would be orchard grass and winter wheat, oats, or rye. The use of a cover crop, typically a small grain, helps in many situations including summer months that are typically a difficult time to establish a ground cover. Increasing the amount of seed (normally 1.5 times the recommended amount) and taking care to use the proper practices to enhance germination and establishment (see Seeding Practices section below) are also helpful during dry summer months. Table 12.2 provides seed recommendations by season.

Many wildlife ground covers such as warm season grasses or species commonly used in wildlife food plots may be attractive and/or beneficial to wildlife. However, they often require equipment and experience not normally available on logging operations. Table 12.3 is a seed mix that provides food for wildlife (ex. using fawn fescue instead of tall fescue), ensures germination over a wide range of conditions, is relatively inexpensive, and can be seeded using practices and equipment available on logging operations. The appropriate seeding rate is 50 pounds per acre under normal conditions. Use a higher rate during summer months or on dry sites.

Table 12.2. Suggested Species and Seed Rates (pounds per acre) by Season

Fall Mix	Early Spring Mix
20# orchard grass	20# orchard grass
5# white clover	5# white clover
50# winter wheat	50# cover crop spring oats
Winter Mix	Spring and Summer Mix
20# orchard grass	20# orchard grass
5# white clover	5# white clover
50# winter wheat, rye	20# millet

Table 12.3. Cost-Effective Seed Mix for Wildlife

Type of Seed	% of Mix
Fawn Fescue	35
Winter Rye	28
Yellow Sweet Clover	12
Orchard Grass	10
Red Clover	5
Birdsfoot Trefoil	5
Timothy	5

Seeding Practices to Enhance Germination and Revegetation

Correct Seeding Rates

The mixes above provide information on the species and amount of seed to be planted on a per acre basis. Determining the acreage of logging areas and determining how to seed the proper amount can be difficult. Appendix 6 provides diagrams to aid in seeding the right amount of small grains and grasses. Use these diagrams to adjust the amount of seed to ensure that the proper amount of seed is being distributed. Too little seed contributes to poor groundcover establishment and too much wastes money.

Loose Soil

Retirement practices such as resurfacing, out-sloping, re-contouring, and building permanent water control structures will generate loose soil. On areas where these practices do not occur back dragging a blade, disking, or similar treatments may be required to establish loose soil. In all cases seeding must be done during or directly after the loose soil has been established.

Fertilizer and Lime

There are occasions where fertilizer and/or lime applications may need to be used to achieve vegetative cover. If fertilizers are used, follow the minimum requirements for fertilizer application (BMP 7). Improper use of fertilizer may result in excessive nutrients in nearby waters. A general fertilizer mix that works for a range of conditions includes nitrogen, phosphorus and potassium at the per acre rates:

- 70 to 80 pounds nitrogen (N)
- 120 pounds phosphorus (P_2O_5)
- 120 pounds potassium (K_2O)

Site and soil specific fertilizer and lime recommendations can be obtained through soil analysis by private companies or through your county Cooperative Extension Service office.

Mulch

Mulching can be effective in protecting seed and encouraging establishment. Table 12.4 provides guidelines for mulching materials and application rates.

Table 12.4. Mulching Materials, Rates, and Uses

Mulch Material and Quality	Rate Per 1000 Sq. Ft.	Acre	Remarks
small grain straw, tall fescue straw, or hay	75 - 100 lbs	1 ½ tons (60 – 80 bales)	Spread uniformly. Leave 10-20% of the area exposed. Subject to wind blowing unless left moist or tied down.
wood fiber cellulose airdried, nontoxic, and no growth-inhibiting substances	37 - 41 lbs	1600 -1800 lbs	Apply with a hydro-mulcher. No tie-down is required. Packaged in 100 lb. bags.
tree bark air-dired, nontoxic and no growth inhibiting substances		6 - 12 tons	Resistant to wind blowing. Decomposes slowly.

Determining Acreage for Seeding Practices

Table 12.5 provides information on the surface area of roads and trails that will help establish the acres that need to be seeded, mulched or limed.

Table 12.5. Road and Trail Surface Area—Determination for Fertilizer, Seed, Lime and Mulch

Road Length (feet)	Road Width (feet)				
	8	10	12	14	18
	Acres				
50	.01	.01	.01	.02	.02
100	.02	.02	.03	.03	.04
250	.05	.06	.07	.08	.10
500	.09	.12	.14	.16	.21
750	.14	.17	.21	.24	.31
1000	.18	.24	.28	.32	.41
1500	.28	.34	.41	.48	.62
2000	.36	.48	.56	.64	.83
5000	.92	1.15	1.38	1.16	2.07
5280	.97	1.21	1.45	1.70	2.18

Determining Acreage of Irregular Shaped Areas

The following procedure can be used to determine the acreage of irregularly shaped areas. To determine acreage and pounds of seed for other areas such as log landings or other disturbed areas, use the following procedure:

1. Measure the width across the area in several locations and determine the average width.
2. Measure the length of the area in several locations and determine the average length.
3. Multiply the average width by the average length to get the square feet of disturbed area.
4. Divide the square feet of disturbed area by 43,560 feet/acre to get the acreage.
5. Multiply the acreage of the area by the recommended amount of seed per acre to determine the amount of seed required.

Determining Pure Live Seed

Pure live seed is determined by multiplying percent germination by percent purity. Divide result into recommended pounds of seed per acre which gives the bulk seed needed. Example: fescue may have 98 percent purity and 80 percent germination. If you need to seed 40 pounds per acre of pure live seed. The procedure would be:

$$0.98 \text{ purity} \times 0.80 \text{ germination} = 0.784$$

$$40 \text{ lbs/acre} \div 0.784 = 51 \text{ lbs of seed needed}$$

Closeout

When operations are finished the following procedures should be implemented to ensure that all retirement BMPs are completed and the site is ready for a final inspection.

- For roads, trails, and landings having the potential to produce muddy water that can directly or indirectly reach streams the following steps should be completed.
 - Resurface (removing ruts and smoothing surfaces) and remove berms that trap water.
 - Construct permanent water control structures.
 - Seed and implement practices to improve revegetation.
- Permanently retire disturbed areas other than roads, trails, and landings that can produce muddy water capable of reaching streams.
- Remove temporary stream or channel crossings and retire these areas.
- Remove logging debris from streams.
- Ensure that logging debris does not block the flow of water in ephemeral channels.
- Remove trash and fluids.

Appendix 1. Kentucky Division of Forestry Regional Offices

The Kentucky Division of Forestry (KDF) has County Rangers assigned to all 120 counties in Kentucky that conduct logging inspections for best management practice implementation. KDF maintains 5 regional offices that, along with the state office located in Frankfort, can be contacted for assistance on logging BMP minimum requirements and to voluntarily schedule a logging best management practice inspection.

Central Region

270-465-5071 or 800-866-1007

Adair, Allen, Barren, Breckinridge, Casey, Clinton, Cumberland, Edmonson, Hardin, Hart, Grayson, Green, Larue, Lincoln, Marion, McCreary, Meade, Metcalfe, Monroe, Pulaski, Rockcastle, Russell, Simpson, Taylor, Warren and Wayne.

North Central Region

502-573-1085 or 800-866-0876

Anderson, Boone, Bourbon, Boyle, Bracken, Bullitt, Campbell, Carroll, Clark, Fayette, Franklin, Gallatin, Garrard, Grant, Harrison, Henry, Jefferson, Jessamine, Kenton, Madison, Mercer, Nelson, Nicholas, Oldham, Owen, Pendleton, Robertson, Scott, Shelby, Spencer, Trimble, Washington and Woodford.

Northeast Region

606-783-8625 or 800-866-0052

Bath, Boyd, Carter, Elliott, Estill, Fleming, Greenup, Johnson, Lawrence, Lewis, Magoffin, Martin, Mason, Menifee, Montgomery, Morgan, Powell, Rowan and Wolfe.

Southeast Region

606-435-6073 or 800-866-0503

Bell, Breathitt, Clay, Floyd, Harlan, Jackson, Knott, Knox, Laurel, Lee, Leslie, Letcher, Owsley, Pike, Perry and Whitley.

West Region

270-824-7527 or 800-866-0770

Ballard, Butler, Calloway, Caldwell, Carlisle, Christian, Crittenden, Daviess, Fulton, Graves, Hancock, Henderson, Hickman, Hopkins, Livingston, Logan, Lyon, Marshall, McCracken, McLean, Muhlenberg, Ohio, Todd, Trigg, Union and Webster.

Appendix 2. Harvest Planning Checklist

There are a number of items and concerns that should be included as part of a harvest plan. The following is a check list to aid in plan development. The check list includes “control points” (C) that impact the location of haul roads, landings and skid trails. Some are evident on topographic maps or satellite images, others can only be identified on the ground. Regardless, their location is critical to developing a harvest plan and should be included on a harvest planning map.

- a good map and/or aerial photos
- define property boundaries (C); mark them with flagging per landowner/timber buyer instructions
- determine potential highway access points (C)
- locate all water bodies (streams, sloughs, springs, ponds, lakes, wetland areas, flood plains) and determine where Streamside Management Zones (SMZs) are required (C)
- locate channels and drains, areas that feed rainwater or groundwater into streams (intermittent streams and ephemeral channels, sinkholes) (C)
- steep slopes that will affect skidding or felling (C)
- areas where soil is likely to erode due to steepness or the type of soil present (C)
- in steeply sloping terrain find benches or saddles – areas which can help to locate roads and trails (C)
- areas of special concern such as seeps, rock outcrops, thin soils, sink holes (C)
- the presence and location of all threatened and endangered species and habitats (C)
- locate historic and pre-historic areas such as grave yards or burial mounds (C)
- know where the merchantable timber is and where the unmerchantable areas are (C)
- existing roads, trails, and landings (C)
- existing stream crossings (C)
- potential locations for landings, haul roads and primary skid trails
- special interests of the land or timber owner and items in the timber sale contract
- time of year of harvest and what areas are excluded from logging during wet weather
- if the property is certified, the certification designation number

Appendix 3. Watermaps

Watermaps is a set of online maps developed by the Kentucky Division of Water to assist in identifying important waters in Kentucky. The Division of Water has developed a special map (Forestry-Special Use Waters) to help loggers and foresters find streams and other waters that have special protection. The Kentucky Master Logger website www.masterlogger.org has information and a link to the Forestry Watermaps viewer (<http://watermaps.ky.gov/forestry.html>).

The Watermaps viewer uses Google Maps and those familiar with this popular mapping program will recognize, and be able to, easily navigate the viewer. The viewer initially shows a topographic map and, once loaded, has special streams and waters delineated in color. These are called Exceptional Use Waters that includes:

- **Wild Rivers:** recreational rivers where logging must adhere to special provisions as far as the eye can see from the river up to 2000 feet away. Before logging contact the Wild Rivers Program at the Office of Kentucky Nature Preserves at 502-573-2886.
- **Cold Water Aquatic Habitat (CAH):** commonly referred to as trout streams where special Streamside Management Zones are required.
- **Outstanding State Resource Waters (OSRW):** high quality waters that are monitored periodically and special care and strict adherence to BMPs is required.
- **Outstanding State Resource Waters Threatened/Endangered Listed Species (OSRW T/E):** streams and rivers containing federally listed threatened or endangered species. BMPs must be followed and in some instances modified, or harvest plans altered to ensure protection of these aquatic species.

Note: Some streams and rivers may be listed as both OSRW and CAH.

Each designation has a specific color. You can move around the map by holding down the left mouse key and moving the mouse. You can zoom in by clicking the mouse, or using the + button located in the top left. Clicking the - button zooms out. At the bottom of the screen are a set of circles that allows you to see different options. Hovering your cursor over them indicates what they are. Legends, for example, allows you to see which color is associated with the different Exceptional Use Waters listed above. By clicking on the Basemap Gallery you can switch to an aerial image. You can zoom in close enough to easily identify areas on the ground. You can use the Measurement Tool to determine horizontal distances and determine the acreage of areas that you define. For the latter you click on the area icon in the Measurement Tool. Move your cursor to the map and click on the corners of the area you wish to determine acreage. You can also draw on the map using the Draw Tool. Finally, you can print a map out and use it for planning.

While Watermaps can be used to make harvest planning maps, it was designed to provide up-to-date information on the location of Exceptional Use Waters. In all cases special care must be used in logging around them and in the case of Cold Water Aquatic Habitats (trout streams) it requires the use of special Streamside Management Zones minimum requirements compared to regular streams and waters. It is also important to note the Outstanding State Resource Waters with Threatened/Endangered Listed Species (OSRW T/E) as these contain federally protected species. These maps are updated as new species become federally protected.

Appendix 4. Water Quality Laws and Regulations

Summary of state water quality and related laws and regulations that impact forestry operations in Kentucky.

Surface Water

Water quality laws known as 401 regulations are a part of the Clean Water Act. The Kentucky Division of Water has been given jurisdiction of these regulations by the U.S. Environmental Protection Agency. These laws state that you cannot pollute the waters of the Commonwealth of Kentucky. Sources of pollution from timber harvesting such as mud, vehicle fluids, and logging debris are not allowed in our streams, lakes, ponds, or sloughs. Pollution from chemical applications of fertilizers, herbicides and insecticides or sediments and organic matter from site preparation or other silvicultural operations are also covered under 401 regulations. Other land and water stewardship activities such as stream-bank restoration and manipulation are covered under these regulations. These regulations also provide special protection to certain aesthetically or ecologically sensitive waters such as the Kentucky Wild Rivers. Kentucky Wild Rivers corridors, a set of 9 stretches of rivers in Kentucky, include the visible land area next to the river up to a maximum distance of 2000 feet. If you wish to change the land use in these corridors, for example cut timber, you must contact the Kentucky Division of Water for a permit. Sections of the 151 laws dealing with floodplains prohibit leaving tree tops in flood plains in a manner that will restrict the flow of water during floods. 404 regulations include the deposition of fill into all the waters of the U.S. The U.S. Corps of Engineers has jurisdiction over these regulations.

The 401, 404, and 151 regulations do not mandate BMP use. However, proper BMP use is the best way to help protect water quality. BMPs are specified and required by the AWQA and Forest Conservation Act and aspects of these laws are discussed below. Occasionally forestry operations may become involved with building low water bridges, streambank manipulation, and removing sand and gravel. If this activity is done on less than 500 feet of stream or river the BMP guidelines should be fol-

lowed. However, if the area disturbed is above this minimum a permit may also be required. Contact the Kentucky Division of Water for details. Also if these types of activities are completed in a water course that drains more than 1 square mile (640 acres) the Kentucky Division of Water must also be contacted. The Kentucky Division of Water, possibly in consultation with other agency personnel, may make recommendations to operators or owners to help them avoid water quality problems.

Agriculture Water Quality Act (AWQA)

This law specifies that landowners owning 10 or more acres and who have agriculture or silviculture (forestry including timber harvesting) operations on their property must have a written Water Quality Plan. The Water Quality Plan specifies the Silviculture BMPs and Streams and Other Waters BMPs which should be used on their property. The landowner is not only required to have a written plan, he or she is also responsible for making sure that the plan is implemented. In most instances, loggers or silvicultural operators will be the ones that will implement the BMPs. Under the AWQA there are specific minimum criteria which must be met for these types of operations. These BMPs and minimum criteria can be found in Kentucky Agricultural Water Quality Plan (see <https://www.uky.edu/bae/awqp>). The BMPs required for logging and referenced in the Kentucky Forest Conservation Act are BMPs 1, 3, 4, 5, 7, and 10 of the Silvicultural BMPs in the Kentucky Agricultural Water Quality Plan. They are reviewed periodically by the Kentucky Forestry Best Management Practices Board (the Silvicultural Sub-Committee of the Agriculture Water Quality Board) and recommendations are made to, and approved by, the Agriculture Water Quality Board and ultimately the Kentucky Division of Water.

Activities Near High-quality Waters and Outstanding National Resources Waters, 40I KAR 5:029, 5:030, and 5:031

Kentucky water quality standards (40I KAR 5:029) require the use of BMPs to protect high-quality waters and outstanding national resources waters listed in 40I KAR 5:030. In addition, outstanding resource waters that support federally listed threatened and endangered species require protection (see 40I KAR 5:031).

Activities Near Wild Rivers, KRS 146.200 et seq. and 401 KAR 4:100-140

The Kentucky Wild Rivers Act and associated regulations give special protection to streams designated as "wild rivers," including regulation of silvicultural activity. Before undertaking any silvicultural activity in a corridor of a designated wild river, the landowner or logger should contact the Wild Rivers Program of the Kentucky Division of Water for applicable regulations and instructions.

Debris in Floodplains, KRS 151.250

The Kentucky Division of Water has authority over the placement of debris (including logging slash) in floodplains of perennial streams that have a drainage area larger than one-square mile. The Division of Water advises that as long as the BMPs for Streamside Management Zones and logging debris are followed, landowners and loggers will be considered in compliance with floodplain regulations that address debris. If these BMPs are not followed, the Kentucky Division of Water can institute enforcement proceedings.

Construction in Floodplains, KRS 151.250

All structures (bridges, berms, or other construction that could obstruct flood flows) that are to be constructed in the floodplain of a perennial stream that drains more than one-square mile require a floodplain permit from the Kentucky Division of Water.

Filling or Draining of Wetlands, U.S. Clean Water Act, Section 404

The U.S. Army Corps of Engineers regulates all filling or draining of wetlands, streams, lakes, or other bodies of water. Normal ongoing silvicultural activities, including building and maintaining forest roads, do not require individual permits, providing certain conditions are met, including adherence to the federal baseline BMPs for forest roads. For detailed information on the silvicultural exemption, contact the Kentucky Division of Forestry.

Activities around Sinkholes and Cave Entrances, KRS 433.870-433.875

The Kentucky Cave Protection Act offers protection to any sinkhole, pit, karst window, and/or sinking stream that has an opening large enough for a person to enter a black zone. The Federal Cave Protection Act is used

to manage nonrenewable cave resources on federal lands. Management techniques include buffer zones around sinkhole and cave entrances to provide food sources for cave life, regulate thermal variations, and prevent sedimentation. Extremely sensitive karst systems can include the entire recharge area as a buffer zone.

Endangered Species in Caves, Federal Register 55:6184-6229 and 56:58804-58836

The Kentucky State Nature Preserves Commission maintains the list of Kentucky plants and animals that are considered endangered, threatened, and of special concern. The U.S. Fish and Wildlife Service administers the federal Endangered Species Act of 1973, as amended in 1990, and the 1991 Candidate Review. Many species protected by these acts live in caves and can be threatened by pollutants entering sinkholes.

Modified Sinkholes

Any sinkhole that has been modified to receive additional storm water runoff can be classified as a Class V Underground Injection Control (UIC) Well, which must be registered and/or permitted by the U.S. Environmental Protection Agency Underground Injection Control Program.

Cave Streams and Other Underground Surface Waters

Kentucky surface water statutes and regulations have defined subterranean streams that flow underground and have discrete banks and channels, such as cave streams, as surface waters. Several karst groundwater basins in the Mammoth Cave National Park that extend well outside of the Park's boundary have been designated as Outstanding Resource Waters and receive the same special protection of species as the blind shrimp in Mammoth Cave.

Karst Groundwater Basin Protection

The federal and state Wellhead Protection Programs are developing karst groundwater basin protection plans for public water supplies that use karst springs or groundwater as their water source.

Appendix 5. One-Step Removal Guidelines for Stream Obstructions

To help to ensure that one-step removal activities will not negatively impact streams, the Kentucky Division of Water recommends the following practices be used:

- The material removed from the channel or floodway should be placed sufficiently upland/landward outside of the floodplain enough to prevent the runoff from re-entering streams and/or wetlands;
- The temporary or permanent disposal and/or side-casting of removed material into wetlands, stream tributaries, side ditches, or other surface water is not allowed under one-step removal and would require appropriate state and federal authorizations before the work is done;
- The removal of vegetation should be limited to the removal of dead snags, loose debris and live vegetation which obstructs stream flow. The stumps and roots of trees and/or shrubs should be left undisturbed to protect against erosion.
- Where obstruction removal is needed, access routes for efficient operation of equipment should be selected to minimize disturbance to the floodplain and riparian areas. All work should be performed outside of the flowing section(s) of the stream preferably from the bank or other temporary access point;
- All disturbed areas outside of the stream channel should be restored to original conditions, reseeded or replanted with native riparian species and mulched in order to prevent erosion and sedimentation; please refer to the following for a suggested riparian species list: <http://water.ky.gov/permitting/Lists/Working%20in%20Streams%20and%20Wetlands/Attachments/1/SpeciesList.pdf>);
- If necessary, equipment which can scoop or lift material out of the channel from the stream bank is recommended for this type of work as long as material is not pushed against the banks or piled in the channel;
- Activities should take place during low-flow or no flow conditions (during late summer or fall);

- Removal of materials should not be conducted during the fish-spawning season (April 15 to June 15);
- Precautions should be taken to prevent petroleum products such as lubricating, engine, or transmission oils and greases, etc. from entering surface waters. Washing, fueling, or servicing of equipment is prohibited where spillage or wash water can impact surface waters;
- For sediment bar excavation, only the material more than 12 inches above the normal water elevation should be removed.
- Agricultural operations, as defined by KRS 224.71-100(1) conducting activities pursuant to KRS 224.71-100 (3), (4), (5), (6), or 10 shall be implementing an Agriculture Water Quality Plan pursuant to KRS 224.71-145.
- The commercial excavation, removal, and sale of gravel requires a permit from the Department of Natural Resources, Division of Mine Reclamation and Enforcement, Non-Coal Review Branch. Please contact Fred Buckner at 502-564-2340 or FredW.Buckner@ky.gov. <http://dmre.ky.gov/NonCoal%20Review%20Branch/Pages/default.aspx>.

If you have any questions about this guidance, please contact the Kentucky Division of Water, Water Quality Certification Section at (502) 564-3410 or <http://water.ky.gov/permitting/Pages/KYWaterQualityCertProg.aspx>.

Appendix 6. Photographic Guide for Seeding Rates

The figures on the following pages provide a visual reference to help determine seeding rate. The figures are to be used for grass seed (ex. orchard grass) and small grains (ex. winter wheat, oats, rye) or a mixture. Compare each 4 by 6 inch figure to several 4 by 6 inch areas on seeded ground.

Grass Seed: Normal Rate

(orchard grass 20 lbs per acre)

Average number of seed by 4 by 6 inch rectangle
= 11, ranging 9 to 12.

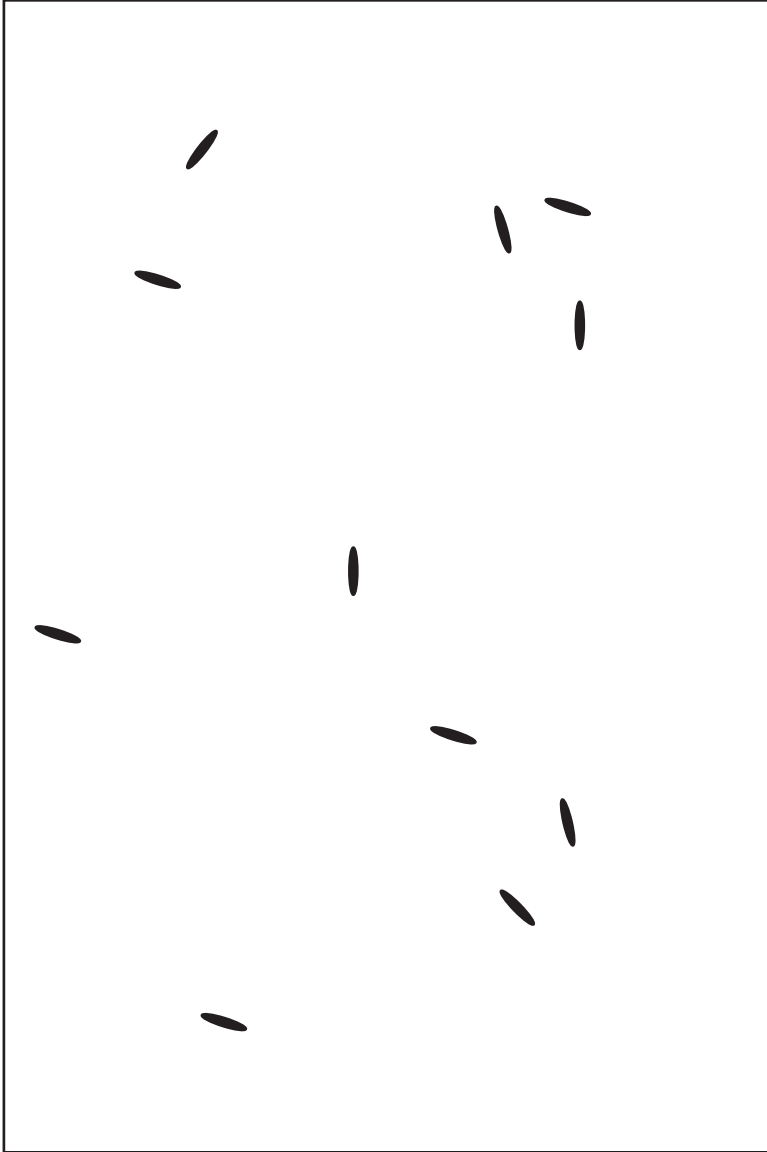

Grass Seed: 1.5 Times Normal Rate

(orchard grass 30 lbs per acre)

Average number of seed by 4 by 6 inch rectangle
= 15, ranging 11 to 20.

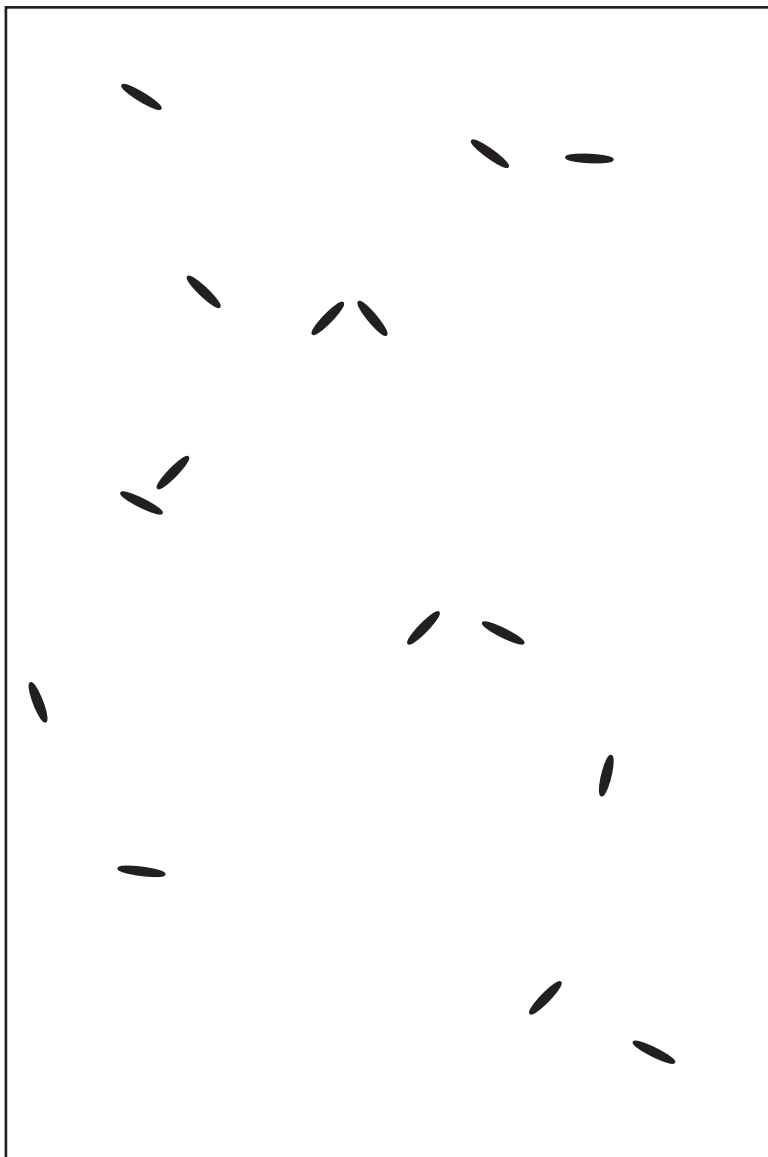

Small Grain: Normal Rate

(winter wheat 50 lbs per acre)

Average number of seed by 4 by 6 inch rectangle
= 2, ranging 1 to 3.

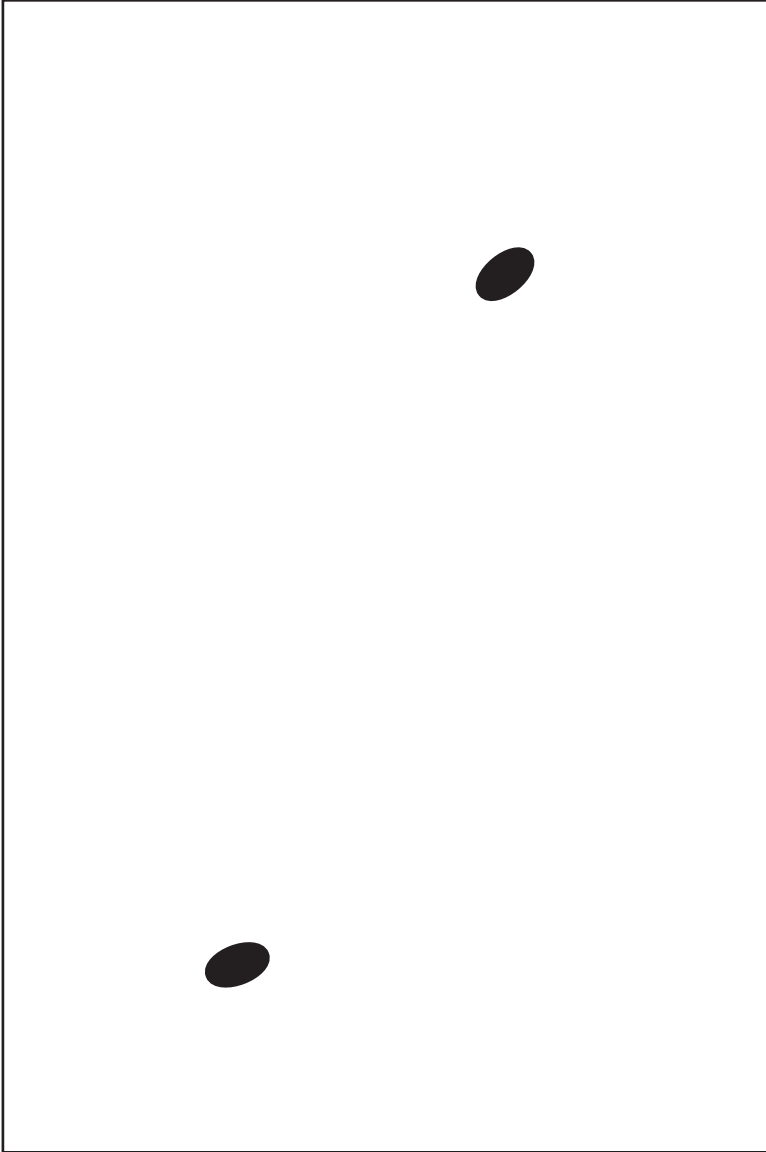

Small Grain: 1.5 Times Normal Rate

(winter wheat 75 lbs per acre)

Average number of seed by 4 by 6 inch rectangle
= 2 to 3, ranging 1 to 4.

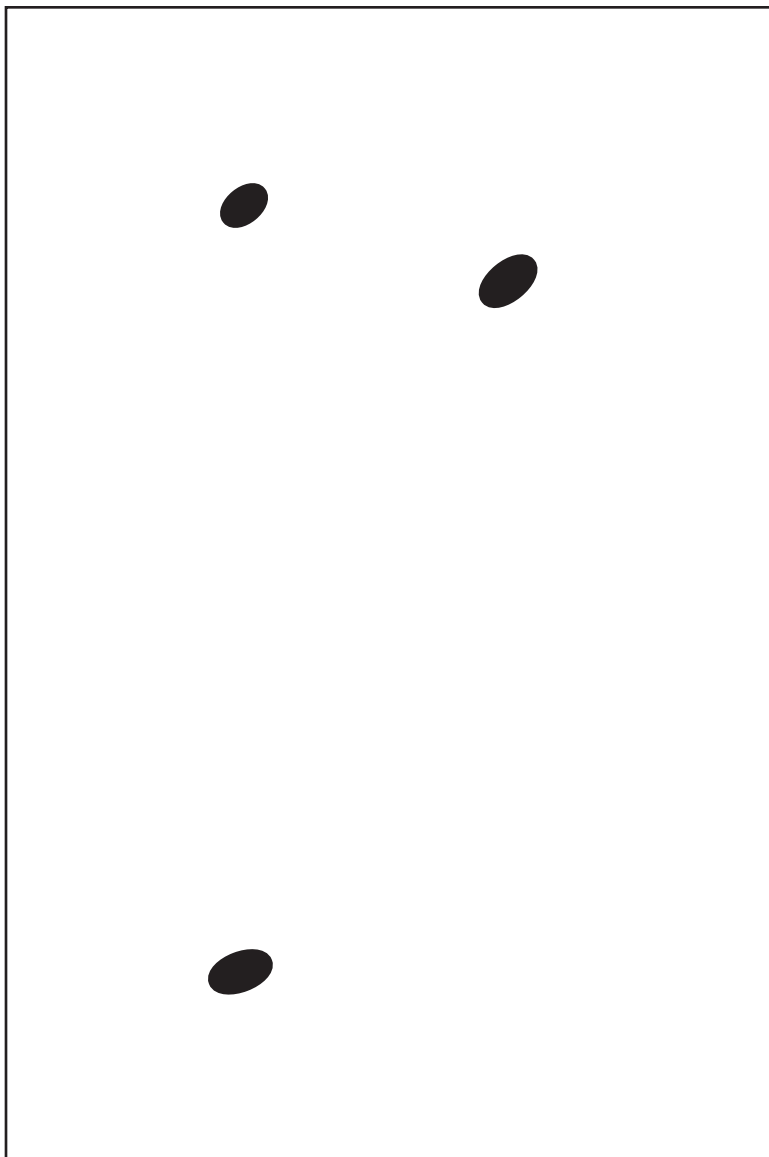

Grass and Small Grain: Normal Rate

(orchard grass 20 lbs and winter wheat 50 lbs per acre)

Average number of seed by 4 by 6 inch rectangle
= 13 ranging 10 to 20.

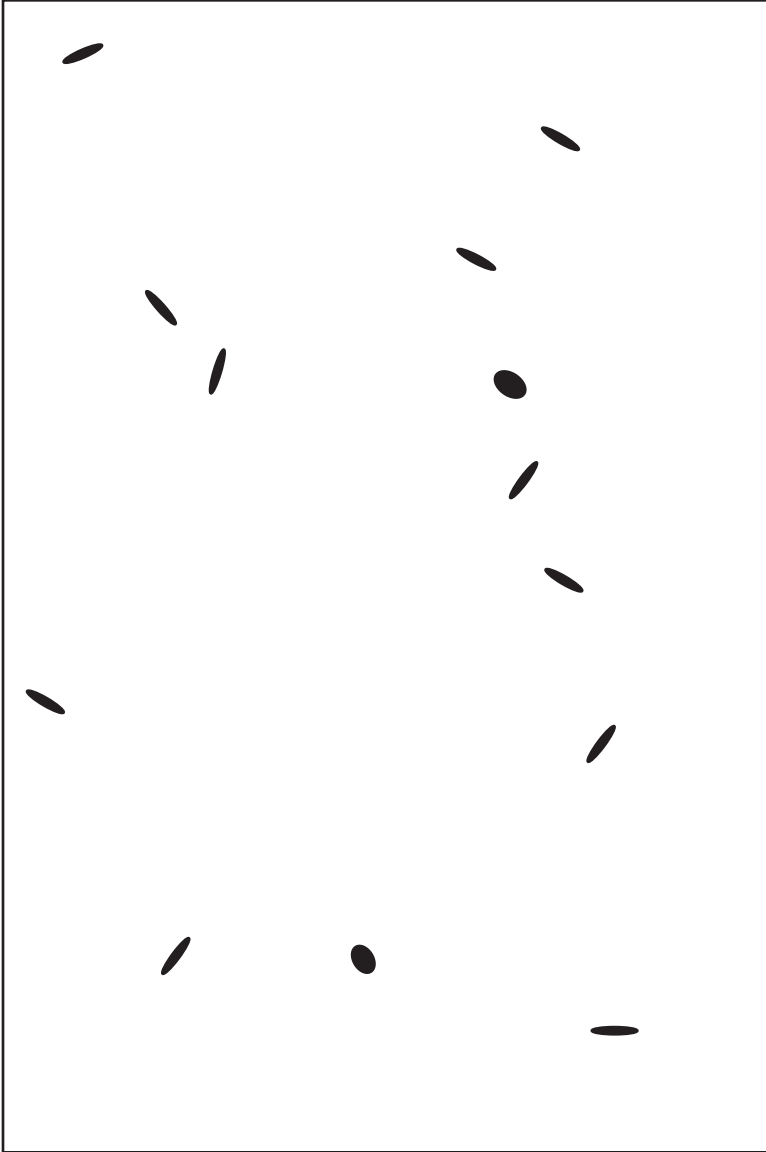

Grass and Small Grain: 1.5 Times Normal Rate

(orchard grass 20 lbs and winter wheat 50 lbs per acre)

Average number of seed by 4 by 6 inch rectangle
= 17 to 20 ranging 12 to 24.

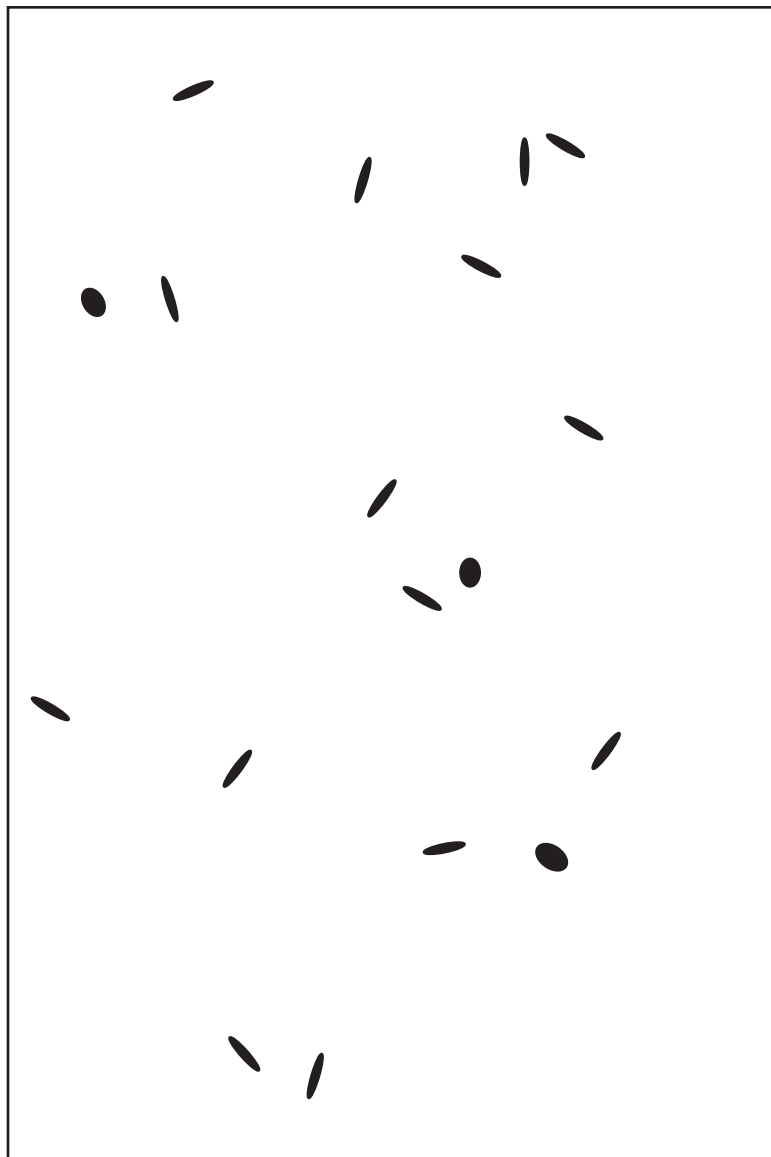

Appendix 7. Glossary of Terms

ACCESS ROAD: Constructed road used to connect a public road to a log deck or landing typically called a haul road.

AVAILABLE EQUIPMENT: Logging or other machinery that is on-site, or has the capacity to be on-site, that can be used to implement and/or construct water control structure and other BMP practices.

BAD ACTOR: Any person engaged in agriculture operations, who receives written notification of documented water pollution and of the agriculture water quality plan needed to prevent water pollution, and is provided technical assistance, and financial assistance when possible, to implement the agriculture water quality plan, but still refuses or fails to comply with the requirements of the agriculture water quality plan.

BERMS: Linear raised disturbed soil on the edge of skid trails and roads that does not allow surface water to flow off of road or trail surfaces.

BEST MANAGEMENT PRACTICES: For forestry operations, the most effective, practical, and economical means of reducing and/or preventing water pollution. In Kentucky, there are mandatory minimum requirements established by the Agriculture Water Quality Act and set forth at silvicultural BMPs in the Statewide Agriculture Water Quality Plan. The Kentucky Forest Conservation Act requires that the silvicultural BMPs pertinent to timber harvesting are used in commercial timber harvests in Kentucky.

BLUE LINE STREAMS: A perennial stream denoted by a continuous blue line appearing on a US Geological Survey 7.5 minute topographic map.

CHANNELS: See ephemeral channel.

COLDWATER AQUATIC HABITATS: Streams or other waters that are designated to hold trout.

DISTURBED SOIL: For the purpose of BMP implementation any area of bare mineral soil that was created during, or a result of, harvesting activity that has the potential to erode.

ELEVATED CROSSING: Crossings that are constructed to provide a trafficking surface above the bed of the stream, channel or ditch.

EPHEMERAL CHANNEL: A natural channel formed by water during or immediately after precipitation events as indicated by an absence of forest litter and exposure of mineral soil, and which conveys surface water directly or indirectly to surface or subsurface streams or other bodies of water.

FORD: Non-elevated crossings established on hard or firm stream or channel beds.

GROUNDWATER: Subsurface water occurring in the zone of saturation beneath the water table and any perched water zones below the B soil horizon.

HAUL ROAD: See access road.

INTERMITTENT STREAM: Has a well defined channel but flowing only during the wet portions of the year. Typically denoted by a broken (dot – dash) blue line on a US Geological Survey topographic map.

LANDINGS: Location where merchantable material (example logs) are collected, potentially processed and loaded onto trucks.

LOGGING DEBRIS/SLASH: Unused parts of trees including tops, limbs, cut-offs, and other residual tree materials.

MINIMUM SURFACE DISTANCES: A slope distance measurement, indicating the minimum required distance between the bank of a stream or other water body and logging roads, skid trails or landings.

NON POINT SOURCE POLLUTION: Pollution that comes from a number of sources spread over a wide geographic area. Generally, each source only contributes a small amount of contamination, but the sum impact may be substantial. Agriculture, mining, forestry, urban runoff, and construction all contribute to non point source pollution. A single source for the pollution is not readily identifiable.

ORIGINAL OVERSTORY TREES: Trees present at the time of logging that naturally would occur through natural or planted stand development, occupying the main forest canopy that have well developed rounded or conical shaped crowns receiving direct sunlight across the top of the crown (dominant and co-dominant crown class trees).

PERMANENT RETIREMENT PRACTICES: A set of practices implemented after logging operations on a site, or a section of site, have been completed to ensure appropriate control of non-point source pollution.

PERENNIAL STREAM: Has a well defined channel and flows all year or nearly all year under typical climatic conditions. Typically denoted by a continuous blue line appearing on a US Geological Survey 7.5 minute topographic map. For BMP purposes requirements for perennial streams also apply to other perennial waters.

SEDIMENT: The result of erosion. It is the solid material, both mineral and organic, that is in suspension, that is being transported, and creates pollution problems.

SKID TRAIL: A temporary pathway used

to drag felled trees or logs to a landing or concentration point, resulting in duff and ground disturbance sufficient to cause erosion.

SINKHOLE: A natural depression where surface water enters underground passages typically occurring in areas underlined with limestone.

STREAMSIDE MANAGEMENT ZONES (SMZ): A strip of land adjacent to either side of a stream or surrounding a lake, pond, or sinkhole. These areas are carefully maintained and managed to protect water quality by filtering sediment, to provide shade to maintain water temperatures, and to trap logging debris.

TEMPORARILY INACTIVE: An entire logging tract or a portion of a logging job where skidding and/or other similar operations have been suspended but will resume.

THREATENED OR ENDANGERED: Designation for a species that is federally listed under the Endangered Species Act, that is afforded protections from harassment, including loss of habitat or habitat quality, or mortality.

TRAILS: See skid trails.

TRASH: Discarded man-made materials, including personal and operational items.

WARM WATER AQUATIC HABITATS: Water bodies not designated as cold-water aquatic habitats. The vast majority of all waters in Kentucky are defined as warm water aquatic habitats.

WATER BODIES: Streams, ponds, lakes, sloughs, and other natural or manmade areas, that hold water permanently or intermittently, and have the potential to contain aquatic animals and/or plants.

WATER CONTROL STRUCTURES: Any construction that collects and directs surface water on or associated with roads, trails, and landings.

WATERMAPS: A set of web applica-

tions developed and maintained by Kentucky Division of Water that shows waters and provides information on their classification using a mapping interface.

WETLAND: Geographic areas which

characteristically support vegetation suited to life in saturated soil conditions, and have hydric (wet) soils and some saturation or flooding during the growing season.

Good Examples of BMP's



Skidder using a crane mat to cross a small perennial stream in south central Kentucky.



Good temporary installation of a steel culvert for a small stream crossing.



Retired skid trail in eastern Kentucky with water bars in place and the skid trail and water bars seeded.



Steel pipe use for crossing a perennial stream using poles as backfill instead of soil.



Poles temporarily set in place with a forwarder to cross a small ephemeral channel.



Wood panels used along a haul road to provide flotation for trucks moving from a public highway to a landing.



Successfully retired skid trail in eastern Kentucky.



Thick grass cover resulting from seeding into loose soil.



Skid trail retired with water control structures and grass established to reduce erosion in central Kentucky.



A high-traffic primary skid trail approaching a landing using steel pipe backfilled with poles to minimize soil in the channel.



Retired skid trail in the process of revegetation resulting from seeding into loose soil directly after removing ruts and installing water bars.

Mention or display of a trademark, proprietary product, or firm in text or figures does not constitute an endorsement and does not imply approval to the exclusion of other suitable products or firms.

Educational programs of Kentucky Cooperative Extension serve all people regardless of economic or social status and will not discriminate on the basis of race, color, ethnic origin, national origin, creed, religion, political belief, sex, sexual orientation, gender identity, gender expression, pregnancy, marital status, genetic information, age, veteran status, or physical or mental disability. Issued in furtherance of Cooperative Extension work, Acts of May 8 and June 30, 1914, in cooperation with the U.S. Department of Agriculture, Nancy M. Cox, Director of Cooperative Extension Programs, University of Kentucky College of Agriculture, Food and Environment, Lexington, and Kentucky State University, Frankfort. Copyright © 2018 for materials developed by University of Kentucky Cooperative Extension. This publication may be reproduced in portions or its entirety for educational or nonprofit purposes only. Permitted users shall give credit to the author(s) and include this copyright notice. Publications are also available on the World Wide Web at www.ca.uky.edu.
Issued 9-2018